

University of Anbar
College of Engineering
Mechanical Engineering Department



Internal Combustion Engines
(Third Stage)

Dr. Ahmed Ali Najeeb Alashaab

References:

1. Engineering Fundamentals of the Internal Combustion Engine by: Willard W. Pulkrabek.
2. Internal combustion engines and air pollution by: E.F. Obert Publisher: intext educational publishers (1973).
3. Internal combustion engine fundamentals, by: John Heywood, pub.: McGraw- Hill (1988) - USA.
4. Internal combustion engines Applied Thermodynamics, by: Colin R Ferguson and Allan T. Kirkpatrick, pub.: John Wiley & sons – 2001.
5. Introduction to internal combustion engines, by: Richard stone, pub.: MacMillan (1992) - USA.
6. A course in internal combustion engines, by: M. L. Mathur And R.P. Sharma, pub.: Dhanpat Rai & sons- India.
7. Internal combustion engines, by: H. B .Keswani, pub.: Standard Book House-India.
8. Internal combustion engines. Theory and Practice, by: S .P. Sen, pub.: Khanna publishers- India.

CHAPTER ONE

HEAT ENGINE

1-1 INTRODUCTION

The **internal combustion engine** (ic) is a heat engine that converts chemical energy in a fuel into mechanical energy, usually made available on a rotating output shaft. Chemical energy of the fuel is first converted to thermal energy by means of combustion or oxidation with air inside the engine. This thermal energy raises the temperature and pressure of the gases within the engine, and the high-pressure gas then expands against the mechanical mechanisms of the engine. This expansion is converted by the mechanical linkages of the engine to a rotating crankshaft, which is the output of the engine. The crankshaft, in turn, is connected to a transmission and/or power train to transmit the rotating mechanical energy to the desired final use. For engines this will often be the propulsion of a vehicle (i.e., automobile, truck, locomotive, marine vessel, or airplane). Other applications include stationary engines to drive generators or pumps, and portable engines for things like chain saws and lawn mowers.

Most internal combustion engines are **reciprocating engines** having pistons that reciprocate back and forth in cylinders internally within the engine. This book concentrates on the thermodynamic study of this type of engine. Other types of IC engines also exist in much fewer numbers, one important one being the rotary engine [104]. These engines will be given brief coverage. Engine types not covered by this book include steam engines and gas turbine engines, which are better classified as **external combustion engines** (i.e., combustion takes place outside the mechanical engine system). Also not included in this book, but which could be classified as internal combustion engines, are rocket engines, jet engines, and firearms. Reciprocating engines can have one cylinder or many, up to 20 or more. The cylinders can be arranged in many different geometric configurations. Sizes range from small model airplane engines with power output on the order of 100 watts to large multicylinder stationary engines that produce thousands of kilowatts per cylinder.

There are so many different engine manufacturers, past, present, and future, that produce and have produced engines which differ in size, geometry, style, and operating characteristics that no absolute limit can be stated for any range of engine characteristics (i.e., size, number of cylinders, strokes in a cycle, etc.).

Comparison between external combustion engine and internal combustion engine:

Internal combustion engine	External combustion engine
* Combustion of air-fuel is inside the engine cylinder (in a boiler)	* Combustion of air-fuel is outside the engine cylinder (in a boiler)
* Very noisy operated engine	* The engines are running smoothly and silently due to outside combustion
* It is light and compact due to lower ratio of weight and bulk to output.	* Higher ratio of weight and bulk to output due to presence of auxiliary apparatus like boiler and condenser. Hence it is heavy and cumbersome.
* Working pressure and temperature inside the engine cylinder is very much high; hence special alloys are used	* Working pressure and temperature inside the engine cylinder is low; hence ordinary alloys are used for the manufacture of engine cylinder and its parts.
* High grade fuels are used with proper filtration	* It can use cheaper fuels including solid fuels
* Higher efficiency about 35-40%	* Lower efficiency about 15-20%
* Lesser requirement of water	* Higher requirement of water for dissipation of energy through cooling system
* IC engines are not self-starting	* High starting torque

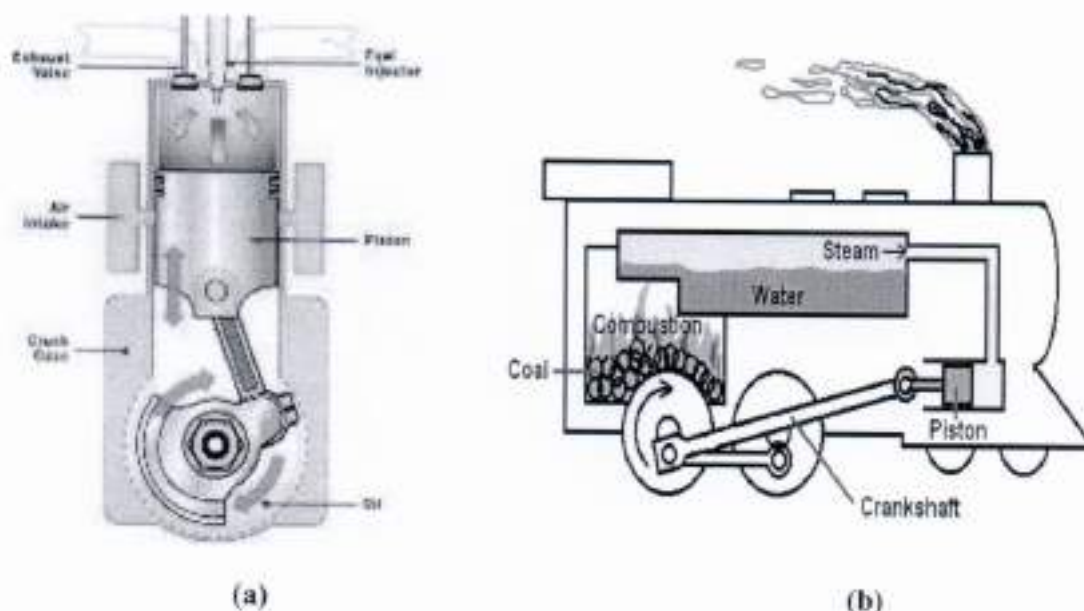

Figure.1: Show (a) Internal combustion Engine, (b) External combustion Engine

1-2 ENGINE CLASSIFICATIONS:

Internal combustion engines can be classified in a number of different ways:

1. Types of Ignition:

(a) **Spark Ignition (SI).** An SI engine starts the combustion process in each cycle by use of a spark plug. The spark plug gives a high-voltage electrical discharge between two electrodes which ignites the air-fuel mixture in the combustion chamber surrounding the plug. In early engine development, before the invention of the electric spark plug, many forms of torch holes were used to initiate combustion from an external flame.

(b) **Compression Ignition (CI).** The combustion process in a CI engine starts when the air-fuel mixture self-ignites due to high temperature in the combustion chamber caused by high compression.

2. Engine Cycle:

(a) **Four-Stroke Cycle.** A four-stroke cycle experiences four piston movements over two engine revolutions for each cycle.

(b) **Two-Stroke Cycle.** A two-stroke cycle has two piston movements over one revolution for each cycle. Three-stroke cycles and six-stroke cycles were also tried in early engine development.

3. Valve Location: (see Fig. 1)

(a) **Valves in head (overhead valve),** also called **I Head engine.**

(b) **Valves in block (flat head),** also called **L Head engine.** Some historic engines with valves in block had the intake valve on one side of the cylinder and the exhaust valve on the other side. These were called **T Head engines.**

(c) One valve in head (usually intake) and one in block, also called **F Head engine;** this is much less common.

4. Basic Design:

(a) **Reciprocating.** Engine has one or more cylinders in which pistons reciprocate back and forth. The combustion chamber is located in the closed end of each cylinder. Power is delivered to a rotating output crankshaft by mechanical linkage with the pistons.

(b) **Rotary.** Engine is made of a block (stator) built around a large non-concentric rotor and crankshaft. The combustion chambers are built into the nonrotating block.

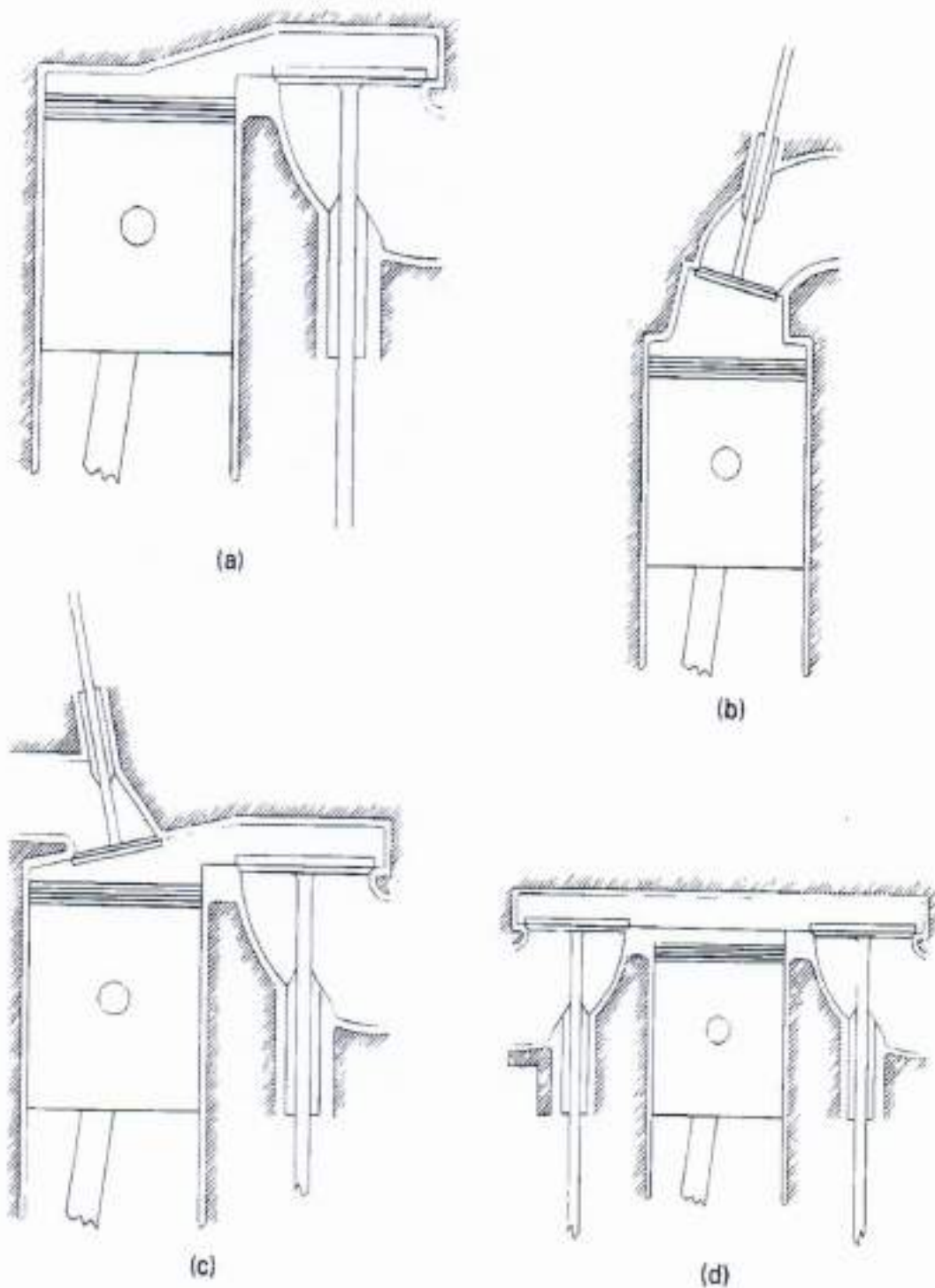

Figure.2: Engine Classification by Valve Location. (a) Valve in block, L head. Older automobiles and some small engines. (b) Valve in head, I head. Standard on modern automobiles. (c) One valve in head and one valve in block, F head. Older, less common automobiles. (d) Valves in block on opposite sides of cylinder, T head. Some historic automobile engines.

5. Position and Number of Cylinders of Reciprocating Engines: (Fig. 3)

(a) **Single Cylinder.** Engine has one cylinder and piston connected to the crankshaft.

(b) **In-Line.** Cylinders are positioned in a straight line, one behind the other along the length of the crankshaft. They can consist of 2 to 11 cylinders or possibly more. In-line four-cylinder engines are very common for automobile and other applications. In-line six and eight cylinders are historically common automobile engines. In-line engines are sometimes called **straight** (e.g., straight six or straight eight).

(c) **V Engine.** Two banks of cylinders at an angle with each other along a single crankshaft. The angle between the banks of cylinders can be anywhere from 15° to 120° , with 60° - 90° being common. V engines have even numbers of cylinders from 2 to 20 or more. V6s and V8s are common automobile engines, with V12s and V16s (historic) found in some luxury and high-performance vehicles.

(d) **Opposed Cylinder Engine.** Two banks of cylinders opposite each other on a single crankshaft (a V engine with a 180° V). These are common on small aircraft and some automobiles with an even number of cylinders from two to eight or more. These engines are often called flat engines (e.g., flat four).

(e) **W Engine.** Same as a V engine except with three banks of cylinders on the same crankshaft. Not common, but some have been developed for racing automobiles, both modern and historic. Usually 12 cylinders with about a 60° angle between each bank.

(f) **Opposed Piston Engine.** Two pistons in each cylinder with the combustion chamber in the center between the pistons. A single-combustion process causes two power strokes at the same time, with each piston being pushed away from the center and delivering power to a separate crankshaft at each end of the cylinder. Engine output is either on two rotating crankshafts or on one crankshaft incorporating complex mechanical linkage.

(g) **Radial Engine.** Engine with pistons positioned in a circular plane around the central crankshaft. The connecting rods of the pistons are connected to a master rod which, in turn, is connected to the crankshaft. A bank of cylinders on a radial engine always has an odd number of cylinders ranging

from 3 to 13 or more. Operating on a four-stroke cycle, every other cylinder fires and has a power stroke as the crankshaft rotates, giving a smooth operation. Many medium- and large-size propeller-driven aircraft use radial engines. For large aircraft, two or more banks of cylinders are mounted together, one behind the other on a single crankshaft, making one powerful, smooth engine. Very large ship engines exist with up to 54 cylinders, six banks of 9 cylinders each.

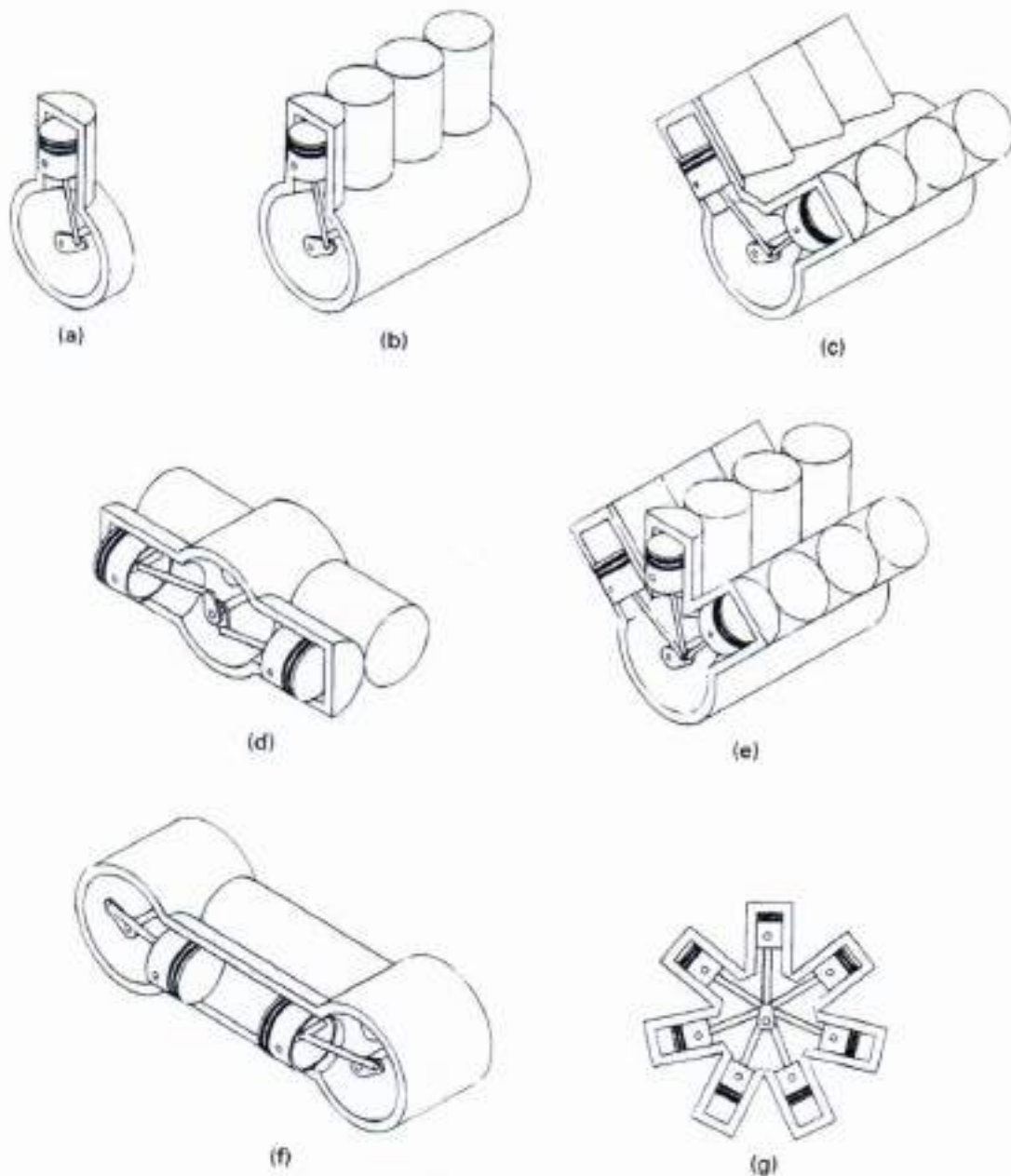

Figure.3: Engine Classification by Cylinder Arrangement (a) Single Cylinder. (b) In-Line.(c) V Engine. (d) Opposed Cylinder Engine. (e) W Engine. (f) Opposed Piston Engine. (g) Radial Engine.

6. Air Intake Process

- (a) Naturally Aspirated. No intake air pressure boost system.
- (b) Supercharged. Intake air pressure increased with the compressor driven off of the engine crankshaft.
- (c) Turbocharged. Intake air pressure increased with the turbine-compressor driven by the engine exhaust gases .
- (d) Crankcase Compressed. Two-stroke cycle engine which uses the crankcase as the intake air compressor. Limited development work has also been done on design and construction of four-stroke cycle engines with crankcase compression.

7. Method of Fuel Input for SI Engines

- (a) Carbureted.
- (b) Multipoint Port Fuel Injection. One or more injectors at each cylinder intake.
- (c) Throttle Body Fuel Injection. Injectors upstream in intake manifold.

8. Fuel Used

- (a) Gasoline.
- (b) Diesel Oil or Fuel Oil.
- (c) Gas, Natural Gas, Methane.
- (d) LPG.
- (e) Alcohol-Ethyl, Methyl.
- (f) Dual Fuel. There are a number of engines that use a combination of two or more fuels. Some, usually large, CI engines use a combination of methane and diesel fuel. These are attractive in developing third-world countries because of the high cost of diesel fuel. Combined gasoline-alcohol fuels are becoming more common as an alternative to straight gasoline automobile engine fuel.
- (g) Gasohol. Common fuel consisting of 90% gasoline and 10% alcohol.

9. Application

- (a) Automobile, Truck, Bus.
- (b) Locomotive.
- (c) Stationary.
- (d) Marine.
- (e) Aircraft.
- (f) Small Portable, Chain Saw, Model Airplane.

10. Type of Cooling

- (a) Air Cooled.
- (b) Liquid Cooled, Water Cooled.

8/16/2018

1-3 Main Components of Reciprocating IC Engines:

Cylinder: It is the main part of the engine inside which piston reciprocates to and fro. It should have high strength to withstand high pressure above 50 bar and temperature above 2000 °C. The ordinary engine is made of cast iron and heavy duty engines are made of steel alloys or aluminum alloys. In the multi-cylinder engine, the cylinders are cast in one block known as cylinder block.

Cylinder head: The top end of the cylinder is covered by cylinder head over which inlet and exhaust valve, spark plug or injectors are mounted. A copper or asbestos gasket is provided between the engine cylinder and cylinder head to make an air tight joint.

Piston: Transmit the force exerted by the burning of charge to the connecting rod. Usually made of aluminum alloy which has good heat conducting property and greater strength at higher temperature.

Piston rings: These are housed in the circumferential grooves provided on the outer surface of the piston and made of steel alloys which retain elastic properties even at high temperature. 2 types of rings- compression and oil rings. Compression ring is upper ring of the piston which provides air tight seal to prevent leakage of the burnt gases into the lower portion. Oil ring is lower ring which provides effective seal to prevent leakage of the oil into the engine cylinder.

Connecting rod: It converts reciprocating motion of the piston into circular motion of the crank shaft, in the working stroke. The smaller end of the connecting rod is connected with the piston by gudgeon pin and bigger end of the connecting rod is connected with the crank with crank pin. The special steel alloys or aluminium alloys are used for the manufacture of connecting rod.

Crankshaft: It converts the reciprocating motion of the piston into the rotary motion with the help of connecting rod. The special steel alloys are used for the manufacturing of the crankshaft. It consists of eccentric portion called crank.

Crank case: It houses cylinder and crankshaft of the IC engine and also serves as sump for the lubricating oil.

Flywheel: It is big wheel mounted on the crankshaft, whose function is to maintain its speed constant. It is done by storing excess energy during the power stroke, which is returned during other stroke.

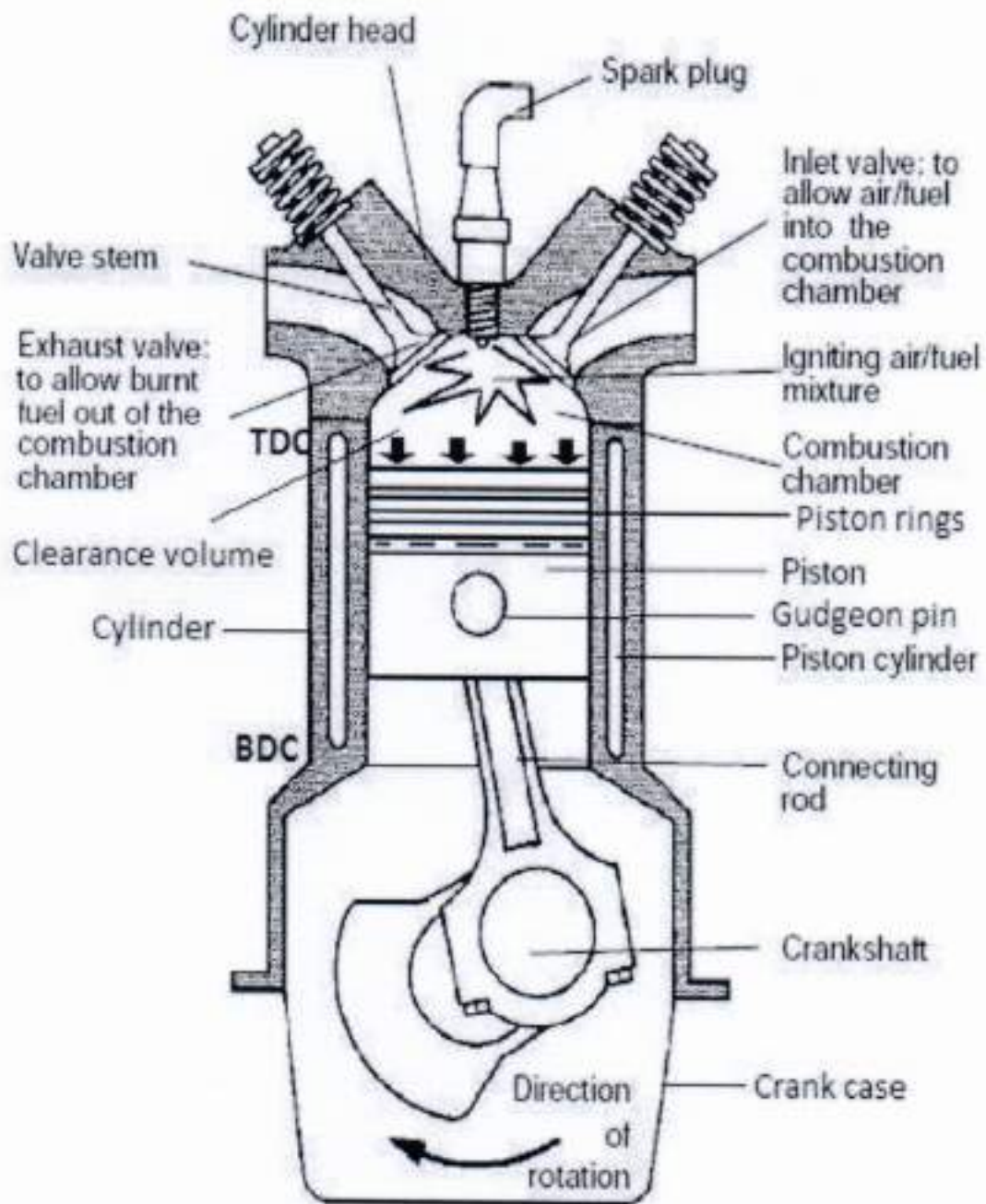

Figure.4: shows the different components of IC engine.

1-4 Terminology used in IC engine:

1. Cylinder bore (D): The nominal inner diameter of the working cylinder.

2. Piston area (A): The area of circle of diameter equal to the cylinder bore.

3. Stroke (L): The nominal distance through which a working piston moves between two successive reversals of its direction of motion.

4. Dead centre: The position of the working piston and the moving parts which are mechanically connected to it at the moment when the direction of the piston motion is reversed (at either end point of the stroke).

(a) Bottom dead centre (BDC): Dead centre when the piston is nearest to the crankshaft.

(b) Top dead centre (TDC): Dead centre when the position is farthest from the crankshaft.

5. Displacement volume or swept volume (V_s): The nominal volume generated by the working piston when travelling from the one dead centre to next one and given as,

$$V_s = A \times L$$

6. Clearance volume (V_c): the nominal volume of the space on the combustion side of the piston at the top dead centre.

7. Cylinder volume (V): Total volume of the cylinder. $V = V_s + V_c$

8. Compression ratio (r): $r = V_s / V_c$

1-5 ENGINE OPERATING CYCLES

1-5-1 Four stroke engine (Spark Ignition SI):

Cycle of operation completed in four strokes of the piston or two revolution of the piston.

(i) **Suction stroke** (suction valve open, exhaust valve closed)-charge consisting of fresh air mixed with the fuel is drawn into the cylinder due to the vacuum pressure created by the movement of the piston from TDC to BDC.

(ii) **Compression stroke** (both valves closed)-fresh charge is compressed into clearance volume by the return stroke of the piston and ignited by the spark for combustion. Hence pressure and temperature is increased due to the combustion of fuel

(iii) **Expansion stroke** (both valves closed)-high pressure of the burnt gases force the piston towards BDC and hence power is obtained at the crankshaft.

(iv) **Exhaust stroke** (exhaust valve open, suction valve closed)- burned gases expel out due to the movement of piston from BDC to TDC.

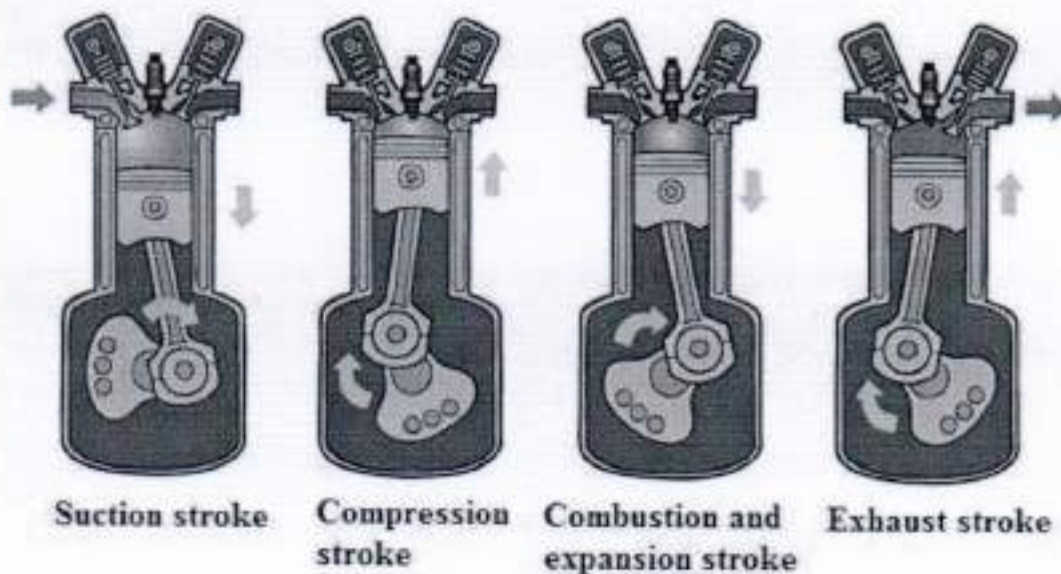

Figure.5: show the cycle of operation of four stroke engine.

1-5-2 Two stroke engine:

The two strokes are:

i. **Compression stroke**, which starts by closing the inlet and exhaust ports, and Then compresses the cylinder contents and draws fresh charge into the crank- case. As the piston approaches TC, combustion is initiated.

ii. **Power or Expansion stroke**, similar to that in the four-stroke cycle until the piston approaches BC, when first the exhaust ports and then the intake ports are uncovered (Fig. 6). Most of the burnt gases exit the cylinder in an exhaust blow down process. When the inlet ports are uncovered, the fresh charge which has been compressed in the crankcase flows into the cylinder.

The piston and the ports are generally shaped to deflect the incoming charge from flowing directly into the exhaust ports and to achieve effective scavenging of the residual gases.

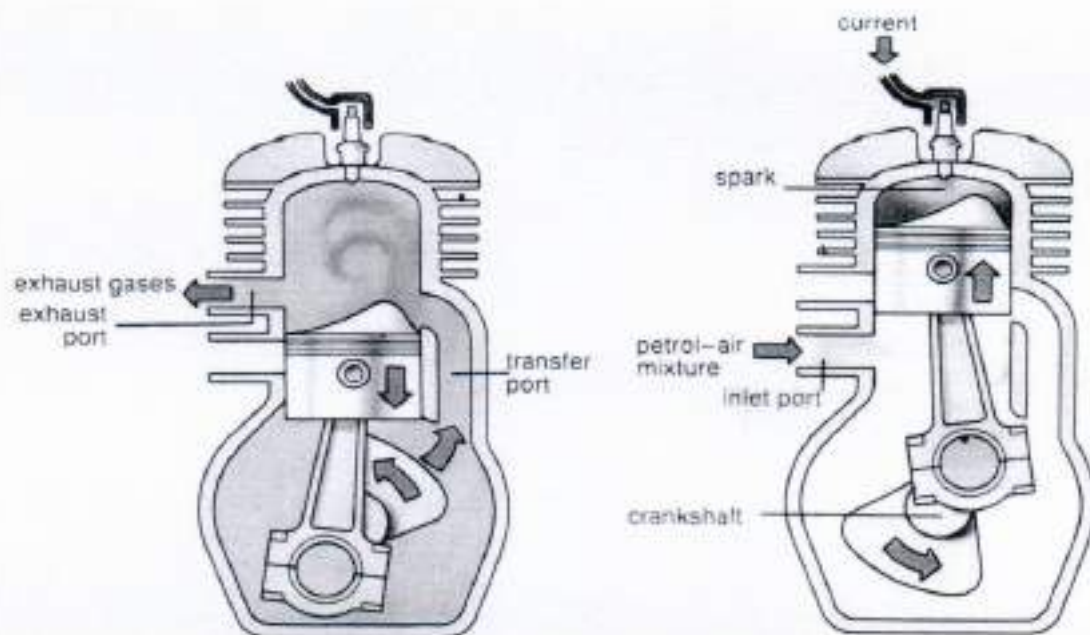

Figure.6: show operation of two stroke engine

1-5-3 Comparison of Four-stroke and two-stroke engine:

	Two-stroke engine	Four-stroke engine
1	Two stroke of the piston and one revolution of crankshaft	Four stroke of the piston and two revolution of crankshaft
2	One power stroke in each revolution of crankshaft	One power stroke in every two revolution of crankshaft
3	Lighter flywheel due to more uniform turning movement	Heavier flywheel due to non-uniform turning movement
4	Theoretically power produce is twice than the four stroke engine for same size	Power produce is less
5	Light and compact	Heavy and bulky
6	Greater cooling and lubrication requirements	Lesser cooling and lubrication requirements
7	Higher rate of wear and tear	Lesser rate of wear and tear
8	Contains ports arrangement	Contains valve and valve mechanism
9	Cheaper initial cost	Higher initial cost
10	Volumetric efficiency less due to lesser time of induction	Volumetric efficiency is more due to greater time of induction
11	Thermal efficiency is low, part load efficiency lesser	Thermal efficiency is high and also part load efficiency better
12	It is used where low cost, compactness and light weight are important. Ex-lawn mowers, scooters, motor cycles, mopeds, propulsion ship etc.	It is used where efficiency is important. Ex-cars, buses, trucks, tractors, industrial engines, aero planes, power generation etc.

1-5-4 Comparison of SI and CI engine:

CI engine	SI engine
Working cycle is diesel cycle.	Working cycle is Otto cycle.
Diesel or high cetane fuel is used.	Petrol or gasoline or high octane fuel is used.
Low self-ignition temperature.	High self-ignition temperature.
Fuel is injected directly into the combustion chamber at high pressure at the end of compression stroke.	Fuel and air introduced as a gaseous mixture in the suction stroke.
Injector and high pressure pump used to supply of fuel. Quantity of fuel regulated in pump.	Carburettor used to provide the mixture. Throttle controls the quantity of mixture introduced.
Self-ignition by the compression of air which increased the temperature required for combustion	Use of spark plug for ignition system
Compression ratio is 14 to 22	Compression ratio is 6 to 10.5
Lower maximum RPM	Higher maximum RPM due to lower weight
Higher maximum efficiency due to higher compression ratio	Maximum efficiency lower due to lower compression ratio
Heavier due to higher pressures	Lighter

1-6 Valve Timing Diagram:

15/10/2018

We consider that the valves open and close at the dead center positions of the piston. But, in actual practice they do not open and close instantaneously at dead centers. The valves operate some degrees before or after the dead centers. The ignition is also timed to occur a little before the top dead center. The timings of these sequence of events can be shown graphically in terms of crank angles from dead center position. This diagram is known as valve timing diagram.

1-6-1 Valve timing diagram for four-stroke petrol engine:

Diagram shows the valve timing diagram for a four-stroke cycle petrol engine. The inlet valve opens $10-30^\circ$ before the top dead center position. The air-fuel mixture is sucked into the engine cylinder till the inlet valve closes. The inlet valve closes $30-40^\circ$ or even 60° after the bottom dead center position. The air-fuel mixture is compressed till the spark occurs.

The spark is produced $20-40^\circ$ before the T.D.C. position. This gives sufficient time for the fuel to burn. The pressure and temperature increases. The burning gases expand and force the piston to do useful work. The burning gases expand till the exhaust valve opens. The exhaust valve opens $30-60^\circ$ before the B.D.C. position. The exhaust gases are forced out of the cylinder till the exhaust valve closes. The exhaust valve closes $8-20^\circ$ after the T.D.C. position. Before it closes, again the inlet valve opens $10-30^\circ$ before the T.D.C. position. The period between the inlet valve opening and exhaust valve closing is known as valve overlap period. The angle between the inlet valve opening and exhaust valve closing is known as angle of valve overlap.

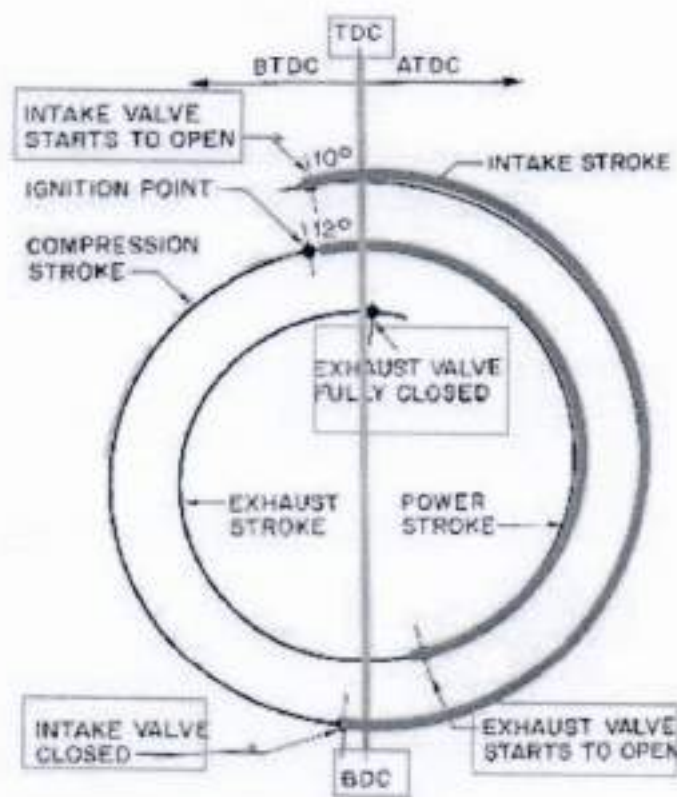

Figure.7: Valve timing diagram for four-stroke petrol engine

1-6-2 Valve Timing Diagram for Four-Stroke Diesel Engine:

The actual valve timing diagram for four-stroke diesel engine is shown in figure. The inlet valve opens $10-25^\circ$ before the top dead center position. Fresh air is sucked into the engine cylinder till the inlet valve closes. The inlet valve closes $25-50^\circ$ after the bottom dead center position. The air is

compressed till the fuel is injected. The fuel injection starts $5-10^\circ$ before the T.D.C. position in the compression stroke. The air fuel mixture burns. The temperature and pressure increases.

The burning gases expand till the exhaust valve opens. The exhaust valve opens $30-50^\circ$ before the B.D.C. position. The exhaust gases are forced out of the engine cylinder till the exhaust valve closes. The exhaust valve closes $10-15^\circ$ after the T.D.C. position. Before the exhaust valve closes, again the inlet valve opens $10-25^\circ$ before the T.D.C. position. The period between the inlet valve opening the exhaust valve closing is known as valve overlap period. The angle between these two events is known as angle of valve overlap.



Figure.8: Valve Timing Diagram for Four-Stroke Diesel Engine

According to the first law of thermodynamics, energy can neither be created nor destroyed. It can only be converted from one form to another. Therefore, there must be an energy balance of input and output to a system. In the reciprocating internal combustion engine the fuel is fed into the combustion chamber where it burns in air converting chemical energy of the fuel into heat. The liberated heat energy cannot be totally utilized for driving the piston as there are losses through the engine exhaust, to the coolant and due to radiation. The heat energy which is converted to power at this stage is called the indicated power, ip and it is utilized to drive the piston. The energy represented by the gas forces on the piston passes through the connecting rod to the crankshaft. In this transmission there are energy losses due to bearing friction, pumping losses etc. In addition, a part of the energy available is utilized in driving the auxiliary devices like feed pump, valve mechanisms, ignition systems etc. The sum of all these losses, expressed in units of power is termed as frictional power, fp . The remaining energy is the useful mechanical energy and is termed as the brake power, bp . In energy balance, generally, frictional power is not shown separately because ultimately this energy is accounted in exhaust, cooling water, radiation, etc.

1.8 ENGINE PERFORMANCE PARAMETERS

17/10

The engine performance is indicated by the term *efficiency*, η . Five important engine efficiencies and other related engine performance parameters are given below:

(i)	Indicated thermal efficiency	(η_{ith})
(ii)	Brake thermal efficiency	(η_{bth})
(iii)	Mechanical efficiency	(η_m)
(iv)	Volumetric efficiency	(η_v)
(v)	Relative efficiency or Efficiency ratio	(η_{rel})
(vi)	Mean effective pressure	(p_m)
(vii)	Mean piston speed	(\bar{s}_p)
(viii)	Specific power output	(P_s)
(ix)	Specific fuel consumption	(sfc)
(x)	Inlet-valve Mach Index	(Z)
(x)	Fuel-air or air-fuel ratio	$(F/A \text{ or } A/F)$
(xi)	Calorific value of the fuel	(CV)

Figure 1.15 shows the diagrammatic representation of energy distribution in an IC engine.

1-7 The First Law of Analysis of Engine Cycle:

Before a detailed thermodynamic analysis of the engine cycle is done, it is desirable to have a general picture of the energy flow or energy balance of the system so that one becomes familiar with the various performance parameters. Figure. 9 shows the energy flow through the reciprocating engine and Figure.10 shows its block diagram as an open system.

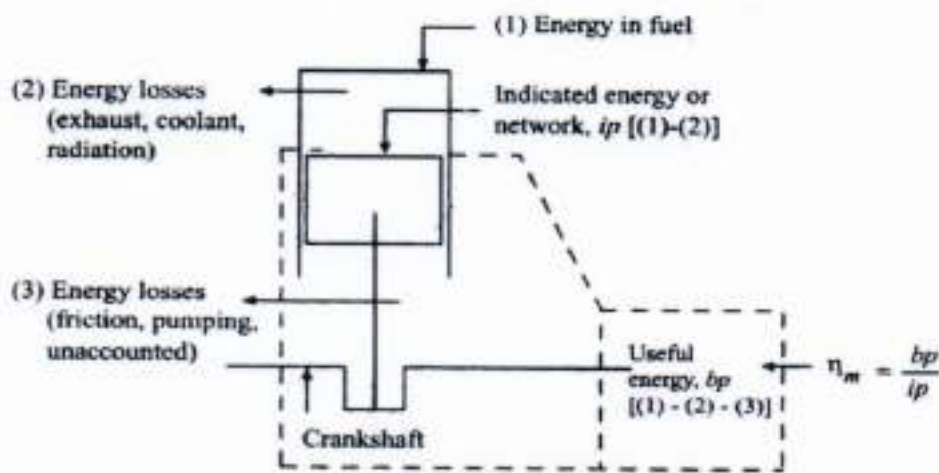

Figure.9: Energy Flow through the Reciprocating Engine

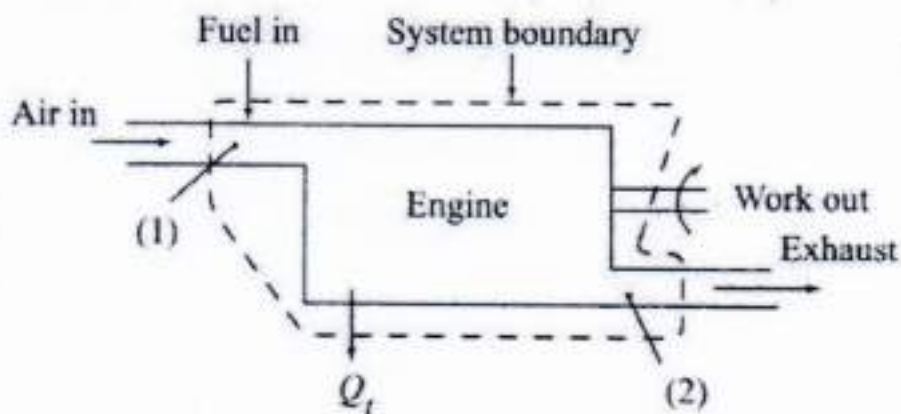

Figure.10: Reciprocating Engine as an Open System

1.8.1 Indicated Thermal Efficiency (η_{ith})

Indicated thermal efficiency is the ratio of energy in the indicated power, ip , to the input fuel energy in appropriate units.

$$[ht]\eta_{ith} = \frac{ip \text{ [kJ/s]}}{\text{energy in fuel per second [kJ/s]}} \quad (1.3)$$

$$= \frac{ip}{\text{mass of fuel/s} \times \text{calorific value of fuel}} \quad (1.4)$$

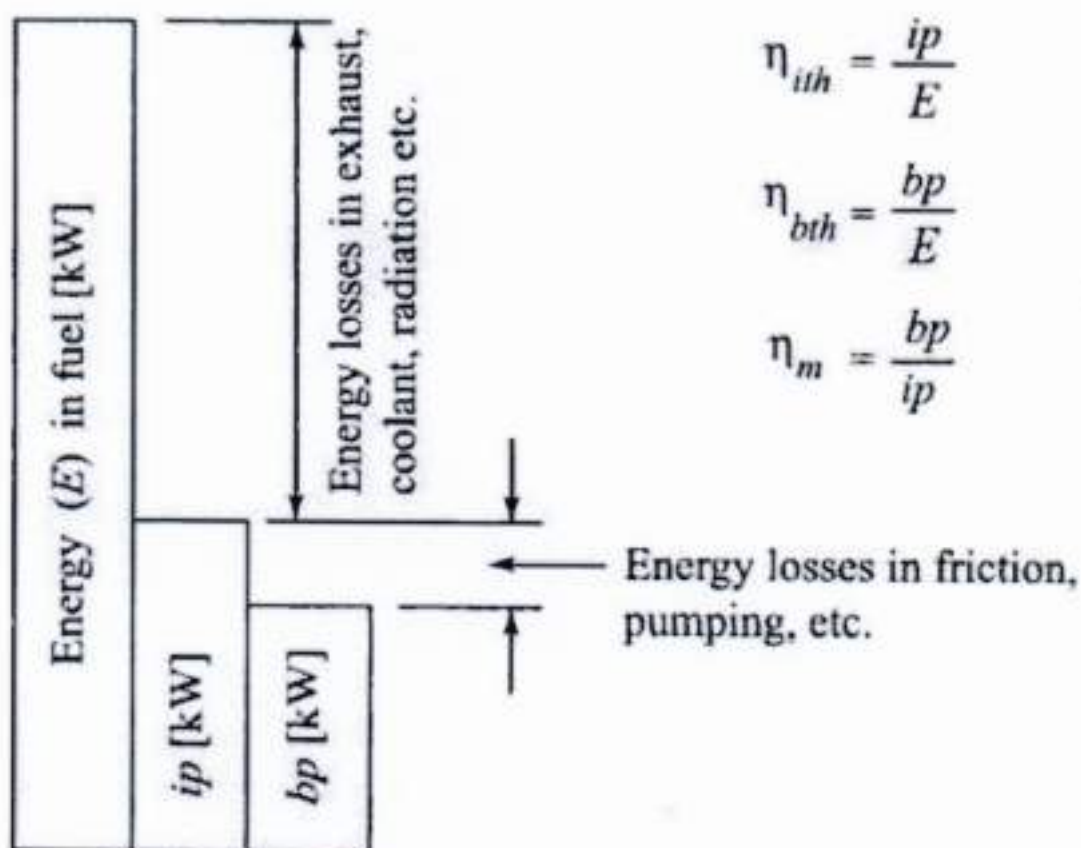

Figure.11: Energy Distribution

1.8.2 Brake Thermal Efficiency (η_{bth})

Brake thermal efficiency is the ratio of energy in the brake power, bp , to the input fuel energy in appropriate units.

$$\eta_{bth} = \frac{bp}{\text{Mass of fuel/s} \times \text{calorific value of fuel}} \quad (1.5)$$

1.8.3 Mechanical Efficiency (η_m)

Mechanical efficiency is defined as the ratio of brake power (delivered power) to the indicated power (power provided to the piston).

$$\eta_m = \frac{bp}{ip} = \frac{bp}{bp + fp} \quad (1.6)$$

$$fp = ip - bp \quad (1.7)$$

It can also be defined as the ratio of the brake thermal efficiency to the indicated thermal efficiency.

1.8.4 Volumetric Efficiency (η_v)

This is one of the very important parameters which decides the performance of four-stroke engines. Four-stroke engines have distinct suction stroke and therefore the volumetric efficiency indicates the breathing ability of the engine. It is to be noted that the utilization of the air is what going to determine the power output of the engine. Hence, an engine must be able to take in as much air as possible.

Volumetric efficiency is defined as the volume flow rate of air into the intake system divided by the rate at which the volume is displaced by the system.

$$\eta_v = \frac{\dot{m}_a}{\rho_a V_{disp} N/2} \quad (1.8)$$

where ρ_a is the inlet density

An alternative equivalent definition for volumetric efficiency is

$$\eta_v = \frac{\dot{m}_a}{\rho_a V_d} \quad (1.9)$$

It is to be noted that irrespective of the engine whether SI, CI or gas engine, *volumetric rate of air flow is what to be taken into account* and not the mixture flow.

If ρ_a is taken as the atmospheric air density, then η_v represents the pumping performance of the entire inlet system. If it is taken as the air density in the inlet manifold, then η_v represents the pumping performance of the inlet port and valve only.

The normal range of volumetric efficiency at full throttle for SI engines is between 80 to 85% where as for CI engines it is between 85 to 90%. Gas engines have much lower volumetric efficiency since gaseous fuel displaces air and therefore the breathing capacity of the engine is reduced.

1.8.5 Relative Efficiency or Efficiency Ratio (η_{rel})

Relative efficiency or efficiency ratio is the ratio of thermal efficiency of an actual cycle to that of the ideal cycle. The efficiency ratio is a very useful criterion which indicates the degree of development of the engine.

$$\eta_{rel} = \frac{\text{Actual thermal efficiency}}{\text{Air-standard efficiency}} \quad (1.10)$$

1.8.6 Mean Effective Pressure (p_m)

Mean effective pressure is the average pressure inside the cylinders of an internal combustion engine based on the calculated or measured power output. It increases as manifold pressure increases. For any particular engine, operating at a given speed and power output, there

will be a specific indicated mean effective pressure, $imep$, and a corresponding brake mean effective pressure, $b MEP$. They are derived from the indicated and brake power respectively. For derivation see Chapter 17. Indicated power can be shown to be

$$ip = \frac{p_{im} L A n K}{60 \times 1000} \quad (1.11)$$

then, the indicated mean effective pressure can be written as

$$p_{im} = \frac{60000 \times ip}{L A n K} \quad (1.12)$$

Similarly, the brake mean effective pressure is given by

$$p_{bm} = \frac{60000 \times bp}{L A n K} \quad (1.13)$$

- where
- ip = indicated power (kW)
 - p_{im} = indicated mean effective pressure (N/m²)
 - L = length of the stroke (m)
 - A = area of the piston (m²)
 - N = speed in revolutions per minute (rpm)
 - n = Number of power strokes
 $N/2$ for 4-stroke and N for 2-stroke engines
 - K = number of cylinders

Another way of specifying the indicated mean effective pressure p_{im} is from the knowledge of engine indicator diagram (p - V diagram). In this case, p_{im} , may be defined as

$$p_{im} = \frac{\text{Area of the indicator diagram}}{\text{Length of the indicator diagram}}$$

where the length of the indicator diagram is given by the difference between the total volume and the clearance volume.

1.8.7 Mean Piston Speed (\bar{s}_p)

An important parameter in engine applications is the mean piston speed, \bar{s}_p . It is defined as

$$\bar{s}_p = 2LN$$

where L is the stroke and N is the rotational speed of the crankshaft in rpm. It may be noted that \bar{s}_p is often a more appropriate parameter than crank rotational speed for correlating engine behaviour as a function of speed.

Resistance to gas flow into the engine or stresses due to the inertia of the moving parts limit the maximum value of \bar{s}_p to within 8 to 15 m/s. Automobile engines operate at the higher end and large marine diesel engines at the lower end of this range of piston speeds.

1.8.8 Specific Power Output (P_s)

Specific power output of an engine is defined as the power output per unit piston area and is a measure of the engine designer's success in using the available piston area regardless of cylinder size. The specific power can be shown to be proportional to the product of the mean effective pressure and mean piston speed.

$$\text{Specific power output, } P_s = bp/A \quad (1.14)$$

$$= \text{constant} \times p_{bm} \times \bar{s}_p \quad (1.15)$$

As can be seen the specific power output consists of two elements, viz., the force available to work and the speed with which it is working. Thus, for the same piston displacement and $bmep$, an engine running at a higher speed will give a higher specific output. It is clear that the output of an engine can be increased by increasing either the speed or the $bmep$. Increasing the speed involves increase in the mechanical stresses of various engine components. For increasing the $bmep$ better heat release from the fuel is required and this will involve more thermal load on engine cylinder.

1.8.9 Specific Fuel Consumption (sfc)

The fuel consumption characteristics of an engine are generally expressed in terms of specific fuel consumption in kilograms of fuel per kilowatt-hour. It is an important parameter that reflects how good the engine performance is. It is inversely proportional to the thermal efficiency of the engine.

$$sfc = \frac{\text{Fuel consumption per unit time}}{\text{Power}} \quad (1.16)$$

Brake specific fuel consumption and indicated specific fuel consumption, abbreviated as $bsfc$ and $isfc$, are the specific fuel consumptions on the basis of bp and ip respectively.

1.8.10 Inlet-Valve Mach Index (Z)

In a reciprocating engine the flow of intake charge takes place through the intake valve opening which is varying during the induction oper-

ation. Also, the maximum gas velocity through this area is limited by the local sonic velocity. Thus gas velocity is finally chosen by the following equation,

$$u = \frac{A_p}{C_i A_i} V_p \quad (1.17)$$

where u = gas velocity through the inlet valve at smallest flow area

A_p = piston area

A_i = nominal intake valve opening area

C_i = inlet valve flow co-efficient

and

$$\frac{u}{\alpha} = \frac{A_p}{A_i} \frac{V_p}{C_i \alpha} = \left(\frac{b}{D_i} \right)^2 \frac{V_p}{C_i \alpha} = Z \quad (1.18)$$

where b = cylinder diameter

D_i = inlet valve diameter

V_p = mean piston speed

α = inlet sonic velocity

C_i = inlet valve average flow co-efficient

Z = inlet valve Mach index.

Large number of experiments have been conducted on CFR single cylinder engine with gaseous mixtures and short induction pipe lengths, at fixed valve timing and fixed compression ratio, but varying inlet valve diameter and lift. The results are quite revealing as regards the relationship of volumetric efficiency versus Mach index are concerned. From Fig.1.16, it could be seen that the maximum volumetric efficiency is obtainable for an inlet Mach number of 0.55. Therefore, engine designers must take care of this factor to get the maximum volumetric efficiency for their engines.

1.8.11 Fuel-Air (F/A) or Air-Fuel Ratio (A/F)

The relative proportions of the fuel and air in the engine are very important from the standpoint of combustion and the efficiency of the engine. This is expressed either as a ratio of the mass of the fuel to that of the air or vice versa.

In the SI engine the fuel-air ratio practically remains a constant over a wide range of operation. In CI engines at a given speed the air flow does not vary with load; it is the fuel flow that varies directly with load. Therefore, the term fuel-air ratio is generally used instead of air-fuel ratio.

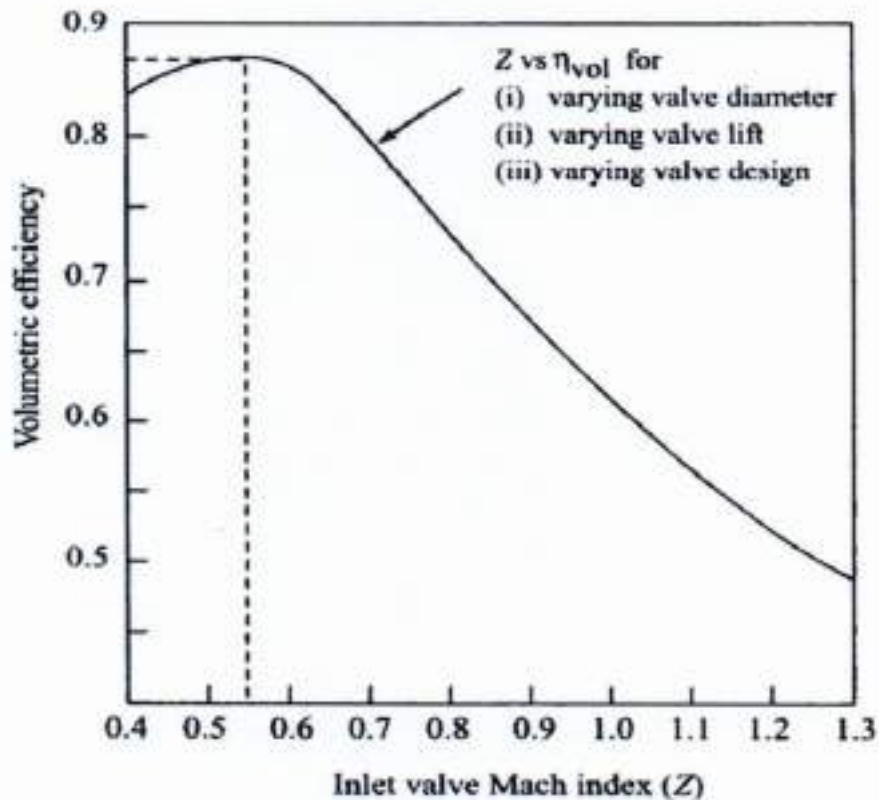

Figure.12: *Inlet-Valve Mach Index*

A mixture that contains just enough air for complete combustion of all the fuel in the mixture is called a chemically correct or stoichiometric fuel-air ratio. A mixture having more fuel than that in a chemically correct mixture is termed as rich mixture and a mixture that contains less fuel (or excess air) is called a lean mixture. The ratio of actual fuel-air ratio to stoichiometric fuel-air ratio is called equivalence ratio and is denoted by ϕ .

$$\phi = \frac{\text{Actual fuel-air ratio}}{\text{Stoichiometric fuel-air ratio}} \quad (1.19)$$

Accordingly, $\phi = 1$ means stoichiometric (chemically correct) mixture, $\phi < 1$ means lean mixture and $\phi > 1$ means rich mixture.

1.8.12 Calorific Value (CV)

Calorific value of a fuel is the thermal energy released per unit quantity of the fuel when the fuel is burned completely and the products of combustion are cooled back to the initial temperature of the combustible mixture. Other terms used for the calorific value are heating value and heat of combustion.

Worked out Examples

- 1.1 The cubic capacity of a four-stroke over-square spark-ignition engine is 245 cc. The over-square ratio is 1.1. The clearance volume is 27.2 cc. Calculate the bore, stroke and compression ratio of the engine.

Solution

$$\text{Cubic capacity, } V_s = \frac{\pi}{4} d^2 L = \frac{\pi}{4} \frac{d^3}{1.1} = 245$$

$$d^3 = 343$$

$$\text{Bore, } d = 7 \text{ cm} \quad \underline{\underline{\text{Ans}}}$$

$$\text{Stroke, } L = \frac{7}{1.1} = 6.36 \text{ cm} \quad \underline{\underline{\text{Ans}}}$$

$$\begin{aligned} \text{Compression ratio, } r &= \frac{V_s + V_c}{V_c} \\ &= \frac{245 + 27.2}{27.2} = 10 \quad \underline{\underline{\text{Ans}}} \end{aligned}$$

- 1.2 The mechanical efficiency of a single-cylinder four-stroke engine is 80%. The frictional power is estimated to be 25 kW. Calculate the indicated power (*ip*) and brake power (*bp*) developed by the engine.

Solution

$$\frac{bp}{ip} = 0.8$$

$$ip - bp = 25$$

$$ip - 0.8 \times ip = 25$$

$$ip = \frac{25}{0.2} = 125 \text{ kW} \quad \underline{\underline{\text{Ans}}}$$

$$bp = ip - fp = 125 - 25 = 100 \text{ kW} \quad \underline{\underline{\text{Ans}}}$$

- 1.3: A four-stroke, four-cylinder diesel engine running at 2000 rpm develops 60 kW. Brake thermal efficiency is 30% and calorific value of fuel (CV) is 42 MJ/kg. Engine has a bore of 120 mm and stroke of 100 mm. Take $\rho_a = 1.15 \text{ kg/m}^3$, air-fuel ratio = 15:1 and $\eta_m = 0.8$. Calculate (i) fuel consumption (kg/s); (ii) air consumption (m^3/s); (iii) indicated thermal efficiency; (iv) volumetric efficiency; (v) brake mean effective pressure and (vi) mean piston speed

Solution

$$\begin{aligned} \text{Fuel consumption, } \dot{m}_f &= \frac{bp}{\eta_{bth} \times CV} = \frac{60}{0.3 \times 42000} \\ &= 4.76 \times 10^{-3} \text{ kg/s} \quad \underline{\underline{\text{Ans}}} \end{aligned}$$

$$\begin{aligned} \text{Air consumption} &= \frac{\dot{m}_f}{\rho_a} \frac{A}{F} = \frac{4.76 \times 10^{-3}}{1.15} \times 15 \\ &= 62.09 \times 10^{-3} \text{ m}^3/\text{s} \quad \underline{\underline{\text{Ans}}} \end{aligned}$$

$$\text{Air flow rate/cylinder} = \frac{62.09 \times 10^{-3}}{4} = 15.52 \times 10^{-3} \text{ m}^3/\text{s}$$

$$\text{Indicated power} = \frac{bp}{\eta_m} = \frac{60}{0.8} = 75 \text{ kW}$$

$$\begin{aligned} \eta_{ith} &= \frac{75}{4.76 \times 10^{-3} \times 42000} \\ &= 0.37515 = 37.51\% \quad \underline{\underline{\text{Ans}}} \end{aligned}$$

Volumetric efficiency =

$$\frac{\text{Actual volume flow rate of air}}{\text{Volume flow rate of air corresponding to displacement volume}} \times 100$$

$$\begin{aligned} \eta_v &= \frac{15.52 \times 10^{-3}}{\frac{\pi}{4} \times 0.12^2 \times 0.10 \times \frac{2000}{120}} \times 100 \\ &= 82.3\% \quad \underline{\underline{\text{Ans}}} \end{aligned}$$

Brake mean effective pressure,

$$\begin{aligned} p_{bm} &= \frac{bp}{LANK} \\ &= \frac{60}{0.1 \times \frac{\pi}{4} \times 0.12^2 \times \frac{2000}{2 \times 60}} \times 10^{-3} \\ &= 7.96 \times 10^5 \text{ N/m}^2 = 7.96 \text{ bar} \quad \underline{\underline{\text{Ans}}} \end{aligned}$$

- 1.4 An one-litre cubic capacity, four-stroke, four-cylinder SI engine has a brake thermal efficiency of 30% and indicated power is 40 kW at full load. At half load, it has a mechanical efficiency of 65%. Assuming constant mechanical losses, calculate: (i) brake power (ii) frictional power (iii) mechanical efficiency at full load (iv) indicated thermal efficiency. If the volume decreases by eight-fold during the compression stroke, calculate the clearance volume.

Solution

Let the brake power at full load be bp and the frictional power be fp .

$$bp + fp = 40 \text{ kW} \quad (1)$$

$$\text{At half load, } bp = 0.5 \times bp \text{ at full load}$$

$$\eta_m = 0.65 = \frac{0.5 bp}{0.5 bp + fp}$$

$$\begin{aligned} 0.5 bp &= 0.65 \times (0.5 \times bp + fp) \\ &= 0.325 \times bp + 0.65 \times fp \end{aligned}$$

$$fp = \frac{0.175}{0.65} \times bp = 0.27bp \quad (2)$$

$$\text{Using (2) in (1) } bp = \frac{40}{1.27} = 31.5 \text{ kW} \quad \underline{\underline{\text{Ans}}}$$

$$fp = 31.5 \times 0.27 = 8.5 \text{ kW} \quad \underline{\underline{\text{Ans}}}$$

$$\eta_m \text{ at full load} = \frac{31.5}{40} = 0.788 = 78.8\% \quad \underline{\underline{\text{Ans}}}$$

$$\eta_{ith} = \frac{\eta_{bth}}{\eta_m} = \frac{30}{78.8} \times 100 = 38\% \quad \underline{\underline{\text{Ans}}}$$

$$\text{Swept volume/cylinder} = \frac{1000}{4} = 250 \text{ cc}$$

$$r = \frac{V_s + V_c}{V_c} = 1 + \frac{V_s}{V_c} = 8$$

$$V_c = \frac{250}{7} = 35.71 \text{ cc} \quad \underline{\underline{\text{Ans}}}$$

1.5 | A four-stroke petrol engine at full load delivers 50 kW. It requires 8.5 kW to rotate it without load at the same speed. Find its mechanical efficiency at full load, half load and quarter load?

Also find out the volume of the fuel consumed per second at full load if the brake thermal efficiency is 25%, given that calorific value of the fuel = 42 MJ/kg and specific gravity of petrol is 0.75. Estimate the indicated thermal efficiency.

Solution

$$\begin{aligned} \text{Mechanical efficiency at full load} &= \frac{bp}{bp + fp} \\ &= \frac{50}{50 + 8.5} = 0.8547 = \mathbf{85.47\%} \quad \underline{\underline{\text{Ans}}} \end{aligned}$$

$$\begin{aligned} \text{Mechanical efficiency at half load} \\ &= \frac{25}{25 + 8.5} = 0.7462 = \mathbf{74.62\%} \quad \underline{\underline{\text{Ans}}} \end{aligned}$$

$$\begin{aligned} \text{Mechanical efficiency at quarter load} \\ &= \frac{12.5}{12.5 + 8.5} = 0.5952 = \mathbf{59.52\%} \quad \underline{\underline{\text{Ans}}} \end{aligned}$$

$$\begin{aligned} \text{Mass flow rate of fuel } \dot{m}_f &= \frac{bp}{\eta_{bth} \times CV} \\ &= \frac{50}{0.25 \times 42000} = 4.76 \times 10^{-3} \text{ kg/s} \end{aligned}$$

$$\begin{aligned} \text{Volume flow rate of fuel} \\ &= \frac{4.76 \times 10^{-3}}{750} = 6.34 \times 10^{-6} \text{ m}^3/\text{s} \quad \underline{\underline{\text{Ans}}} \end{aligned}$$

$$\begin{aligned} \text{Indicated thermal efficiency at full load} \\ \eta_{ith} &= \frac{\eta_{bth}}{\eta_m} = \frac{0.25}{0.8547} = 0.2925 = \mathbf{29.25\%} \quad \underline{\underline{\text{Ans}}} \end{aligned}$$

CHAPTER TWO

AIR-STANDARD CYCLES AND THEIR ANALYSIS

2.1 INTRODUCTION

The operating cycle of an internal combustion engine can be broken down into a sequence of separate processes viz., intake, compression, combustion, expansion and exhaust. The internal combustion engine does not operate on a thermodynamic cycle as it involves an open system i.e., the working fluid enters the system at one set of conditions and leaves at another. However, it is often possible to analyze the open cycle as though it were a closed one by imagining one or more processes that would bring the working fluid at the exit conditions back to the condition of the starting point.

The accurate analysis of internal combustion engine processes is very complicated. In order to understand them it is advantageous to analyze the performance of an idealized closed cycle that closely approximates the real cycle. One such approach is the air-standard cycle, which is based on the following assumptions:

- (i) The working medium is assumed to be a perfect gas and follows the relation $pV = mRT$ or $p = \rho RT$.
- (ii) There is no change in the mass of the working medium.
- (iii) All the processes that constitute the cycle are reversible.
- (iv) Heat is assumed to be supplied from a constant high temperature source and not from chemical reactions during the cycle.

- (v) Some heat is assumed to be rejected to a constant low temperature sink during the cycle.
- (vi) It is assumed that there are no heat losses from the system to the surroundings.
- (vii) The working medium has constant specific heats throughout the cycle.
- (viii) The physical constants viz., C_p , C_v , γ and M of working medium are the same as those of air at standard atmospheric conditions. For example in SI units,

$$\begin{array}{ll}
 C_p = 1.005 \text{ kJ/kg K} & M = 29 \text{ kg/kmol} \\
 C_v = 0.717 \text{ kJ/kg K} & \gamma = 1.4
 \end{array}$$

Due to these assumptions, the analysis becomes over-simplified and the results do not agree with those of the actual engine. Work output, peak pressure, peak temperature and thermal efficiency based on air-standard cycles will be the maximum that can be attained and will differ considerably from those of the actual engine. It is often used, mainly because of the simplicity in getting approximate answers to the complicated processes in internal combustion engines.

In this chapter, we will review the various cycles and also derive the equations for work output, mean effective pressure, efficiency etc. Also, comparison will be made between Otto, Dual and Diesel cycles to see which cycle is more efficient under a set of given operating conditions.

2.2 THE OTTO CYCLE

The main drawback of the Carnot cycle is its impracticability due to high pressure and high volume ratios employed with comparatively low mean effective pressure. Nicolaus Otto (1876), proposed a constant-volume heat addition cycle which forms the basis for the working of today's spark-ignition engines. The cycle is shown on p - V and T - s diagrams in Fig. 2.1(a) and 2.1(b) respectively.

When the engine is working on full throttle, the processes 0→1 and 1→0 on the p - V diagram represents suction and exhaust processes and their effect is nullified. The process 1→2 represents isentropic compression of the air when the piston moves from

pressure as well as isothermal processes. Since the process 2→3 and 3→4 are parallel to each other on the T - s diagram, the net effect is that the heat need be added only at constant temperature $T_3 = T_4$ and rejected at the constant temperature $T_1 = T_2$.

The cycle is shown on p - V and T - s diagrams in Fig. 4.1(a) and 4.1(b) respectively. The advantage of the Ericsson cycle over the Carnot and Stirling cycles is its smaller pressure ratio for a given ratio of maximum to minimum specific volume with higher mean effective pressure.

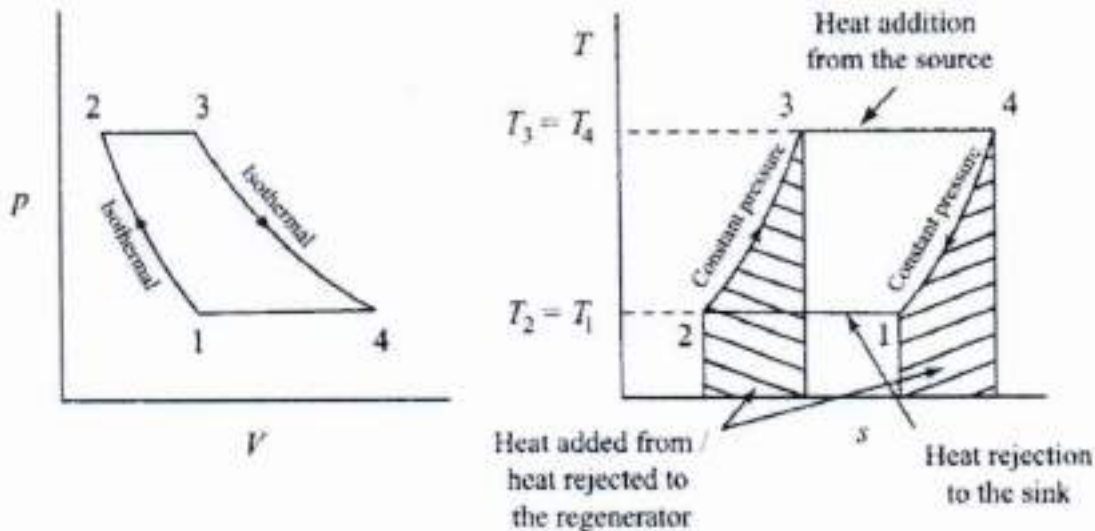

Fig. 4.1 Ericsson Cycle

The Ericsson cycle does not find practical application in piston engines but is approached by a gas turbine employing a large number of stages with heat exchangers, insulators and reheaters.

2-3 THE OTTO CYCLE

The main drawback of the Carnot cycle is its impracticability due to high pressure and high volume ratios employed with comparatively low mean effective pressure. Nicolaus Otto (1876), proposed a constant-volume heat addition cycle which forms the basis for the working of today's spark-ignition engines. The cycle is shown on p - V and T - s diagrams in Fig. 2.1(a) and 2.1(b) respectively.

When the engine is working on full throttle, the processes 0→1 and 1→0 on the p - V diagram represents suction and exhaust processes and their effect is nullified. The process 1→2 represents isentropic compression of the air when the piston moves from

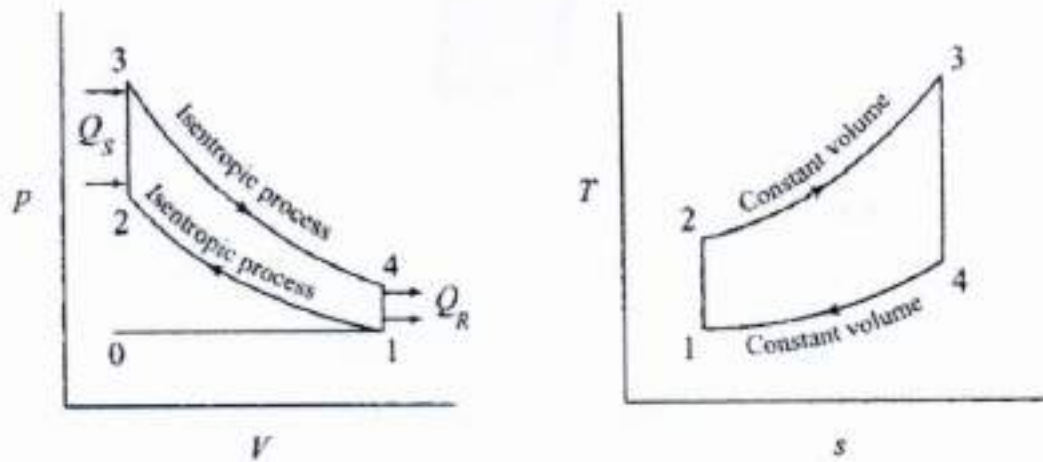

Fig. 3 Otto Cycle

bottom dead centre to top dead centre. During the process 2→3 heat is supplied reversibly at constant volume. This process corresponds to spark-ignition and combustion in the actual engine. The processes 3→4 and 4→1 represent isentropic expansion and constant volume heat rejection respectively.

2.3.5.1 Thermal Efficiency

The thermal efficiency of Otto cycle can be written as

$$\eta_{Otto} = \frac{Q_S - Q_R}{Q_S} \quad (3.14)$$

Considering constant volume processes 2→3 and 4→1, the heat supplied and rejected of air can be written as

$$Q_S = mC_v(T_3 - T_2) \quad (3.15)$$

$$Q_R = mC_v(T_4 - T_1) \quad (3.16)$$

$$\begin{aligned} \eta_{Otto} &= \frac{m(T_3 - T_2) - m(T_4 - T_1)}{m(T_3 - T_2)} \\ &= 1 - \frac{T_4 - T_1}{T_3 - T_2} \quad (3.17) \end{aligned}$$

Considering isentropic processes 1→2 and 3→4, we have

$$\frac{T_2}{T_1} = \left(\frac{V_1}{V_2}\right)^{(\gamma-1)} \quad (3.18)$$

and

$$\frac{T_3}{T_4} = \left(\frac{V_4}{V_3}\right)^{(\gamma-1)} \quad (6.20)$$

But the volume ratios V_1/V_2 and V_4/V_3 are equal to the compression ratio, r . Therefore,

$$\frac{V_1}{V_2} = \frac{V_4}{V_3} = r \quad (7.20)$$

therefore,

$$\frac{T_2}{T_1} = \frac{T_3}{T_4} \quad (8.20)$$

From Eq.3.21, it can be easily shown that

$$\frac{T_4}{T_3} = \frac{T_1}{T_2} = \frac{T_4 - T_1}{T_3 - T_2} \quad (9.20)$$

$$\eta_{Otto} = 1 - \frac{T_1}{T_2} \quad (10.20)$$

$$= 1 - \frac{1}{\left(\frac{V_4}{V_2}\right)^{(\gamma-1)}} \quad (11.20)$$

$$= 1 - \frac{1}{r^{(\gamma-1)}} \quad (12.20)$$

Note that the thermal efficiency of Otto cycle is a function of compression ratio r and the ratio of specific heats, γ . As γ is assumed to be a constant for any working fluid, the efficiency is increased by increasing the compression ratio. Further, the efficiency is independent of heat supplied and pressure ratio. The use of gases with higher γ values would increase efficiency of Otto cycle. Fig. 3.4 shows the effect of γ and r on the efficiency.

3.3.2 Work Output

The net work output for an Otto cycle can be expressed as

$$W = \frac{p_3V_3 - p_4V_4}{\gamma - 1} - \frac{p_2V_2 - p_1V_1}{\gamma - 1} \quad (13)$$

Also

$$\frac{p_2}{p_1} = \frac{p_3}{p_4} = r^\gamma$$

$$\frac{p_3}{p_2} = \frac{p_4}{p_1} = r_p \quad (\text{say}) \quad (14)$$

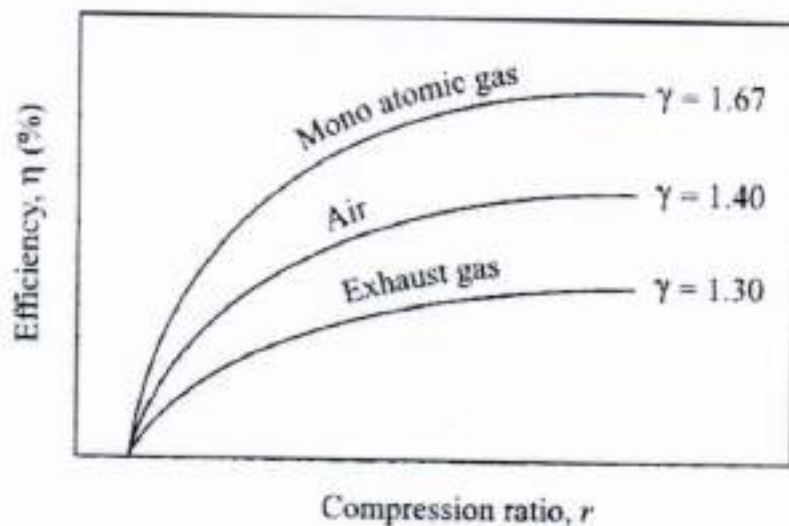

Fig. 14 Effect of r and γ on Efficiency for Otto Cycle

$$V_1 = rV_2 \quad \text{and} \quad V_4 = rV_3$$

therefore,

$$W = \frac{p_1 V_1}{\gamma - 1} \left(\frac{p_3 V_3}{p_1 V_1} - \frac{p_4 V_4}{p_1 V_1} - \frac{p_2 V_2}{p_1 V_1} + 1 \right) \quad (15)$$

$$= \frac{p_1 V_1}{\gamma - 1} \left(\frac{r_p r^\gamma}{r} - r_p - \frac{r^\gamma}{r} + 1 \right)$$

$$= \frac{p_1 V_1}{\gamma - 1} (r_p r^{\gamma-1} - r_p - r^{\gamma-1} + 1)$$

$$= \frac{p_1 V_1}{\gamma - 1} (r_p - 1)(r^{\gamma-1} - 1) \quad (16)$$

2.3.3 Mean Effective Pressure

The mean effective pressure of the cycle is given by

$$p_m = \frac{\text{Work output}}{\text{Swept volume}} \quad (17)$$

$$\text{Swept volume} = V_1 - V_2 = V_2(r - 1)$$

$$p_m = \frac{\frac{1}{\gamma-1} p_1 V_1 (r_p - 1) (r^{\gamma-1} - 1)}{V_2(r - 1)}$$

$$= \frac{p_1 r (r_p - 1) (r^{\gamma-1} - 1)}{(\gamma - 1)(r - 1)} \quad (18)$$

Thus, it can be seen that the work output is directly proportional to pressure ratio, r_p . The mean effective pressure which is an indication of the internal work output increases with a pressure ratio at a fixed value of compression ratio and ratio of specific heats. For an Otto cycle, an increase in the compression ratio leads to an increase in the mean effective pressure as well as the thermal efficiency.

2.4 THE DIESEL CYCLE

In actual spark-ignition engines, the upper limit of compression ratio is limited by the self-ignition temperature of the fuel. This limitation on the compression ratio can be circumvented if air and fuel are compressed separately and brought together at the time of combustion. In such an arrangement fuel can be injected into the cylinder which contains compressed air at a higher temperature than the self-ignition temperature of the fuel. Hence the fuel ignites on its own accord and requires no special device like an ignition system in a spark-ignition engine. Such engines work on heavy liquid fuels. These engines are called compression-ignition engines and they work on a ideal cycle known as Diesel cycle. The difference between Otto and Diesel cycles is in the process of heat addition. In Otto cycle the heat addition takes place at constant volume whereas in the Diesel cycle it is at constant pressure. For this reason, the Diesel cycle is often referred to as the constant-pressure cycle. It is better to avoid this term as it creates confusion with Joules cycle. The Diesel cycle is shown on p - V and T - s diagrams in Fig. 5(a) and 5(b) respectively.

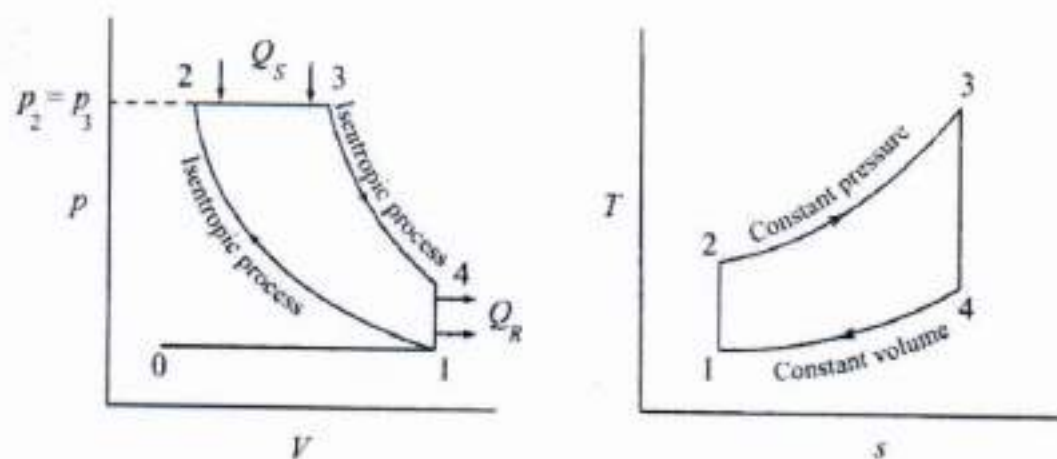

Fig. 5 Diesel Cycle

To analyze the diesel cycle the suction and exhaust strokes, represented by 0→1 and 1→0, are neglected as in the case of the Otto cycle. Here, the volume ratio $\frac{V_1}{V_2}$ is the compression ratio, r . The volume ratio $\frac{V_3}{V_2}$ is called the cut-off ratio, r_c .

2.4.1 Thermal Efficiency

The thermal efficiency of the Diesel cycle is given by

$$\begin{aligned}\eta_{Diesel} &= \frac{Q_S - Q_R}{Q_S} \\ &= \frac{mC_p(T_3 - T_2) - mC_v(T_4 - T_1)}{mC_p(T_3 - T_2)} \quad (3.19)\end{aligned}$$

$$\begin{aligned}&= 1 - \frac{C_v(T_4 - T_1)}{C_p(T_3 - T_2)} \\ &= 1 - \frac{1}{\gamma} \left(\frac{T_4 - T_1}{T_3 - T_2} \right) \quad (3.20)\end{aligned}$$

Considering the process 1→2

$$T_2 = T_1 \left(\frac{V_1}{V_2} \right)^{(\gamma-1)} = T_1 r^{(\gamma-1)} \quad (3.21)$$

Considering the constant pressure process 2→3, we have

$$\begin{aligned}\frac{V_2}{T_2} &= \frac{V_3}{T_3} \\ \frac{T_3}{T_2} &= \frac{V_3}{V_2} = r_c \quad (\text{say}) \\ T_3 &= T_2 r_c \quad (3.22)\end{aligned}$$

From Eqs. 3.34 and 3.35, we have

$$T_3 = T_1 r^{(\gamma-1)} r_c \quad (3.23)$$

Considering process 3→4, we have

$$\begin{aligned}T_4 &= T_3 \left(\frac{V_3}{V_4} \right)^{(\gamma-1)} \\ &= T_3 \left(\frac{V_3}{V_2} \times \frac{V_2}{V_4} \right)^{(\gamma-1)}\end{aligned} \quad (3.24)$$

$$= T_3 \left(\frac{r_c}{r} \right)^{(\gamma-1)} \quad (25)$$

From Eqs. 3.36 and 3.37, we have

$$\begin{aligned} T_4 &= T_1 r^{(\gamma-1)} r_c \left(\frac{r_c}{r} \right)^{(\gamma-1)} = T_1 r_c^\gamma \\ \eta_{Diesel} &= 1 - \frac{1}{\gamma} \left[\frac{T_1 (r_c^\gamma - 1)}{T_1 (r^{(\gamma-1)} r_c - r^{(\gamma-1)})} \right] \\ &= 1 - \frac{1}{\gamma} \left[\frac{(r_c^\gamma - 1)}{r^{(\gamma-1)} r_c - r^{(\gamma-1)}} \right] \\ &= 1 - \frac{1}{r^{(\gamma-1)}} \left[\frac{r_c^\gamma - 1}{\gamma (r_c - 1)} \right] \quad (26) \end{aligned}$$

It may be noted that the efficiency of the Diesel cycle is different from that of the Otto cycle only in the bracketed factor. This factor is always greater than unity. Hence for a given compression ratio, the Otto cycle is more efficient. In diesel engines the fuel cut-off ratio, r_c , depends on output, being maximum for maximum output. Therefore, unlike the Otto cycle the air-standard efficiency of the Diesel cycle depends on output. The higher efficiency of the Otto cycle as compared to the Diesel cycle for the same compression ratio is of no practical importance. In practice the operating compression ratios of diesel engines are much higher compared to spark-ignition engines working on Otto cycle. The normal range of compression ratio for diesel engine is 16 to 20 whereas for spark-ignition engines it is 6 to 10. Due to the higher compression ratios used in diesel engines the efficiency of a diesel engine is more than that of the gasoline engine.

2.6.2 Work Output

The net work output for a Diesel cycle is given by

$$\begin{aligned} W &= p_2(V_3 - V_2) + \frac{p_3 V_3 - p_4 V_4}{\gamma - 1} - \frac{p_2 V_2 - p_1 V_1}{\gamma - 1} \\ &= p_2 V_2 (r_c - 1) + \frac{p_3 r_c V_2 - p_4 r V_2}{\gamma - 1} - \frac{p_2 V_2 - p_1 r V_2}{\gamma - 1} \\ &= V_2 \left[\frac{p_2 (r_c - 1) (\gamma - 1) + p_3 r_c - p_4 r - (p_2 - p_1 r)}{\gamma - 1} \right] \end{aligned} \quad (27)$$

$$\begin{aligned}
 &= V_2 \left[\frac{p_2(r_c - 1)(\gamma - 1) + p_3 \left(r_c - \frac{p_3}{p_2} r \right) - p_2 \left(1 - \frac{p_1}{p_2} r \right)}{\gamma - 1} \right] \\
 &= p_2 V_2 \left[\frac{(r_c - 1)(\gamma - 1) + \left(r_c - r_c^\gamma r^{(1-\gamma)} \right) - \left(1 - r^{(1-\gamma)} \right)}{\gamma - 1} \right] \\
 &= \frac{p_1 V_1 r^{(\gamma-1)} \left[\gamma(r_c - 1) - r^{(1-\gamma)}(r_c^\gamma - 1) \right]}{\gamma - 1} \quad (28)
 \end{aligned}$$

2.4.3 Mean Effective Pressure

The expression for mean effective pressure can be shown to be

$$p_{me} = \frac{p_1 V_1 \left[r^{(\gamma-1)} \gamma (r_c - 1) - (r_c^\gamma - 1) \right]}{(\gamma - 1) V_1 \left(\frac{r-1}{r} \right)} \quad (29)$$

$$= \frac{p_1 \left[\gamma r^\gamma (r_c - 1) - r (r_c^\gamma - 1) \right]}{(\gamma - 1)(r - 1)} \quad (30)$$

2.5 THE DUAL CYCLE

In the Otto cycle, combustion is assumed at constant volume while in Diesel cycle combustion is at constant pressure. In practice they are far from real. Since, some time interval is required for the chemical reactions during combustion process, the combustion cannot take place at constant volume. Similarly, due to rapid uncontrolled combustion in diesel engines, combustion does not occur at constant pressure. The Dual cycle, also called a mixed cycle or limited pressure cycle, is a compromise between Otto and Diesel cycles. Figures 6.4(a) and 6.4(b) show the Dual cycle on p - V and T - s diagrams respectively.

In a Dual cycle a part of the heat is first supplied to the system at constant volume and then the remaining part at constant pressure.

2.5.1 Thermal Efficiency

The efficiency of the cycle may be written as

$$\eta_{Dual} = \frac{Q_S - Q_R}{Q_S} \quad (31)$$

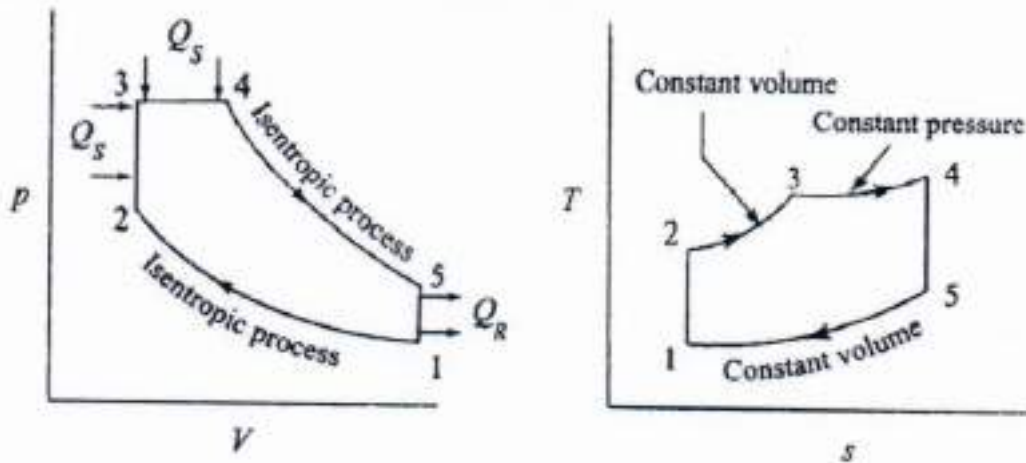

Fig. 3.3 Dual Cycle

$$\begin{aligned}
 &= \frac{mC_v(T_3 - T_2) + mC_p(T_4 - T_3) - mC_v(T_5 - T_1)}{mC_v(T_3 - T_2) + mC_p(T_4 - T_3)} \\
 &= 1 - \frac{T_5 - T_1}{(T_3 - T_2) + \gamma(T_4 - T_3)} \quad (3.46)
 \end{aligned}$$

Now,

$$T_2 = T_1 \left(\frac{V_1}{V_2} \right)^{(\gamma-1)} = T_1 r^{(\gamma-1)} \quad (3.47)$$

$$T_3 = T_2 \left(\frac{p_3}{p_2} \right) = T_1 r_p r^{(\gamma-1)} \quad (3.48)$$

where r_p is the pressure ratio in the constant volume heat addition process and is equal to $\frac{p_3}{p_2}$.

Cut-off ratio r_c is given by $\left(\frac{V_4}{V_3} \right)$

$$T_4 = T_3 \frac{V_4}{V_3} = T_3 r_c$$

Substituting for T_3 from Eq.3.47

$$T_4 = T_1 r_c r_p r^{(\gamma-1)} \quad (3.49)$$

and

$$T_5 = T_4 \left(\frac{V_4}{V_5} \right)^{(\gamma-1)} = T_1 r_p r_c r^{(\gamma-1)} \left(\frac{V_4}{V_5} \right)^{(\gamma-1)} \quad (3.50)$$

Now

$$\frac{V_4}{V_5} = \frac{V_4}{V_1} = \frac{V_4}{V_3} \times \frac{V_3}{V_1} \quad (3.51)$$

$$= \frac{V_4}{V_3} \times \frac{V_2}{V_1} \quad (\text{since } V_2 = V_3)$$

Therefore,

$$\frac{V_4}{V_5} = \frac{r_c}{r} \quad (3.8)$$

where $\frac{V_4}{V_5}$ is the expansion ratio. Now,

$$\begin{aligned} T_5 &= T_1 r_p r_c r^{\gamma-1} \left(\frac{r_c}{r} \right)^{\gamma-1} \\ &= T_1 r_p r_c^\gamma \end{aligned} \quad (3.9)$$

Substituting for T_2, T_3, T_4 and T_5 into Eq.3.45 and simplifying

$$\eta = 1 - \frac{1}{r^{(\gamma-1)}} \left[\frac{r_p r_c^\gamma - 1}{(r_p - 1) + r_p \gamma (r_c - 1)} \right] \quad (3.10) \quad 40$$

It can be seen from the above equation that a value of $r_p > 1$ results in an increased efficiency for a given value of r_c and γ . Thus the efficiency of Dual cycle lies between that of the Otto cycle and the Diesel cycle having same compression ratio.

With $r_c = 1$, it becomes an Otto cycle, and with $r_p = 1$, it becomes a Diesel cycle.

2.5.2 Work Output

The net work output of the cycle is given by

$$\begin{aligned} W &= p_3(V_4 - V_3) + \frac{p_4 V_4 - p_5 V_5}{\gamma - 1} - \frac{p_2 V_2 - p_1 V_1}{\gamma - 1} \\ &= \frac{p_1 V_1}{\gamma - 1} \left[(\gamma - 1) \left(\frac{p_4 V_4}{p_1 V_1} - \frac{p_3 V_3}{p_1 V_1} \right) + \frac{p_4 V_4}{p_1 V_1} - \frac{p_5 V_5}{p_1 V_1} - \frac{p_2 V_2}{p_1 V_1} + 1 \right] \\ &= \frac{p_1 V_1}{\gamma - 1} \left[(\gamma - 1) (r_c r_p r^{\gamma-1} - r_p r^{\gamma-1}) + r_c r_p r^{\gamma-1} \right. \\ &\quad \left. - r_p r_c^\gamma - r^{\gamma-1} + 1 \right] \\ &= \frac{p_1 V_1}{\gamma - 1} \left[\gamma r_c r_p r^{\gamma-1} - \gamma r_p r^{\gamma-1} + r_p r^{\gamma-1} - r_p r_c^\gamma - r^{\gamma-1} + 1 \right] \\ &= \frac{p_1 V_1}{\gamma - 1} \left[\gamma r_p r^{\gamma-1} (r_c - 1) + r^{\gamma-1} (r_p - 1) - (r_p r_c^\gamma - 1) \right] \quad (3.11) \quad 41 \end{aligned}$$

2.4.3 Mean Effective Pressure

The mean effective pressure is given by

$$\begin{aligned}
 p_m &= \frac{\text{Work output}}{\text{Swept volume}} = \frac{W}{V_s} \\
 &= \frac{1}{V_1 - V_2} \frac{p_1 V_1}{\gamma - 1} \left[\gamma r_p r^{\gamma-1} (r_c - 1) + r^{\gamma-1} (r_p - 1) - (r_p r_c^\gamma - 1) \right] \\
 &= \frac{1}{\left(1 - \frac{V_2}{V_1}\right)} \frac{p_1}{(\gamma - 1)} \left[\gamma r_p r^{\gamma-1} (r_c - 1) + r^{\gamma-1} (r_p - 1) \right. \\
 &\quad \left. - (r_p r_c^\gamma - 1) \right] \\
 &= p_1 \frac{[\gamma r_p r^\gamma (r_c - 1) + r^\gamma (r_p - 1) - r(r_p r_c^\gamma - 1)]}{(\gamma - 1)(r - 1)} \quad (2.4.3)
 \end{aligned}$$

2.5 COMPARISON OF THE OTTO, DIESEL AND DUAL CYCLES

The important variable factors which are used as the basis for comparison of the cycles are compression ratio, peak pressure, heat addition, heat rejection and the net work. In order to compare the performance of the Otto, Diesel and Dual combustion cycles some of the variable factors must be fixed. In this section, a comparison of these three cycles is made for the same compression ratio, same heat addition, constant maximum pressure and temperature, same heat rejection and net work output. This analysis will show which cycle is more efficient for a given set of operating conditions.

2.5.1 Same Compression Ratio and Heat Addition

The Otto cycle $1 \rightarrow 2 \rightarrow 3 \rightarrow 4 \rightarrow 1$, the Diesel cycle $1 \rightarrow 2 \rightarrow 3' \rightarrow 4' \rightarrow 1$ and the Dual cycle $1 \rightarrow 2 \rightarrow 2'' \rightarrow 3'' \rightarrow 4'' \rightarrow 1$ are shown in p - V and T - s diagrams in Fig. 2.5(a) and 2.5(b) respectively for the same compression ratio and heat input.

From the T - s diagram, it can be seen that Area $5236 = \text{Area } 523'6' = \text{Area } 522''3''6''$ as this area represents the heat input which is the same for all cycles.

All the cycles start from the same initial state point 1 and the air is compressed from state 1 to 2 as the compression ratio is same. It is seen from the T - s diagram for the same heat input, the heat rejection in Otto cycle (area 5146) is minimum and heat rejection

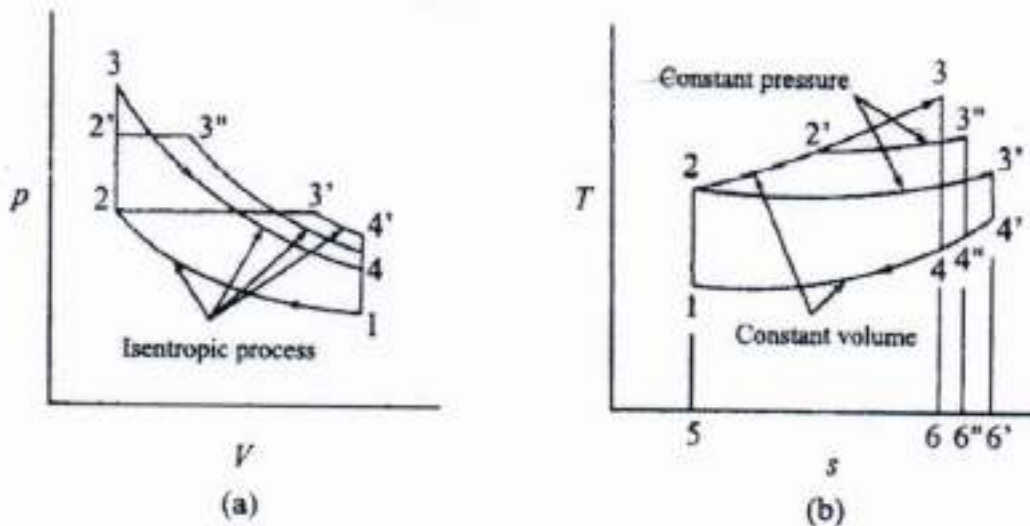

Fig. 3.9 Same Compression Ratio and Heat Addition

in Diesel cycle (514'6') is maximum. Consequently Otto cycle has the highest work output and efficiency. Diesel cycle has the least efficiency and Dual cycle having the efficiency between the two.

One more observation can be made i.e., Otto cycle allows the working medium to expand more whereas Diesel cycle is least in this respect. The reason is heat is added before expansion in the case of former (Otto cycle) and the last portion of heat supplied to the fluid has a relatively short expansion in case of the latter (Diesel cycle).

3.6.2 Same Compression Ratio and Heat Rejection

Efficiency of Otto cycle is given by [Figs. 3.10(a) and 3.10(b)]

$$\eta_{\text{Otto}} = 1 - \frac{Q_R}{Q_S}$$

where Q_S is the heat supplied in the Otto cycle and is equal to the area under the curve 2→3 on the T - s diagram [Fig. 3.10(b)]. The efficiency of the Diesel cycle is given by

$$\eta_{\text{Diesel}} = 1 - \frac{Q_R}{Q'_S}$$

where Q'_S is heat supplied in the Diesel cycle and is equal to the area under the curve 2→3' on the T - s diagram [Fig. 3.10(b)].

From the T - s diagram in Fig. 3.10 it is clear that $Q_S > Q'_S$ i.e., heat supplied in the Otto cycle is more than that of the Diesel cycle. Hence, it is evident that, the efficiency of the Otto cycle is greater

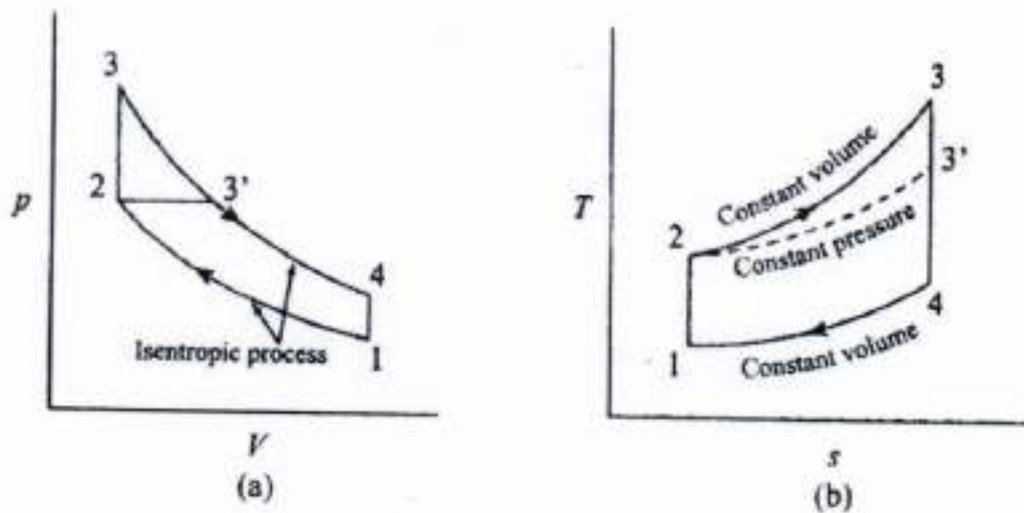

Fig. 8. Same Compression Ratio and Heat Rejection

than the efficiency of the Diesel cycle for a given compression ratio and heat rejection.

2.6.3 Same Peak Pressure, Peak Temperature and Heat Rejection

Figures 9(a) and 9(b) show the Otto cycle 1→2→3→4 and Diesel cycle 1→2'→3→4 on p-V and T-s coordinates, where the peak pressure and temperature and the amount of heat rejected are the same.

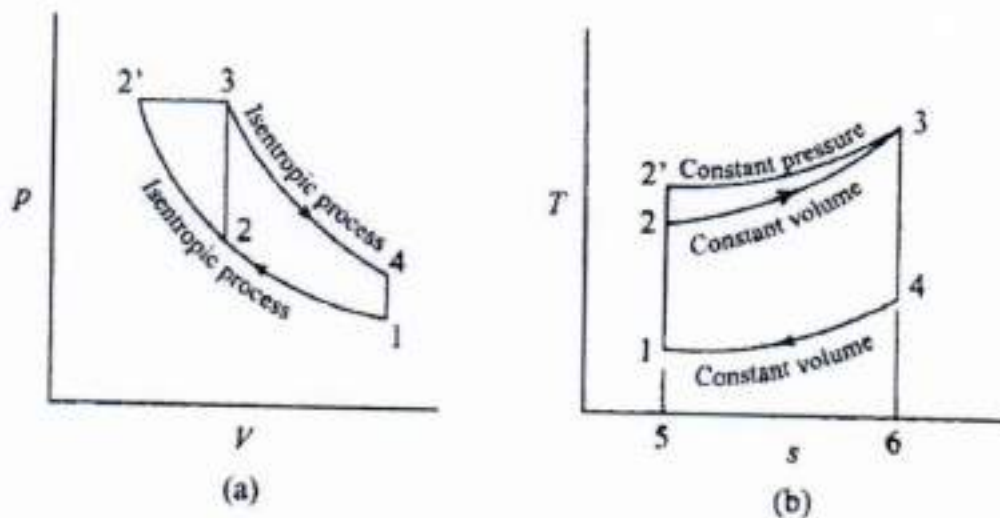

Fig. 9. Same Peak Pressure and Temperature

The efficiency of the Otto cycle $1 \rightarrow 2 \rightarrow 3 \rightarrow 4$ is given by

$$\eta_{Otto} = 1 - \frac{Q_R}{Q_S}$$

where Q_S is the area under the curve $2 \rightarrow 3$ in Fig. 3.11(b).

The efficiency of the Diesel cycle, $1 \rightarrow 2 \rightarrow 3' \rightarrow 3 \rightarrow 4$ is

$$\eta_{Diesel} = 1 - \frac{Q_R}{Q'_S}$$

where Q'_S is the area under the curve $2' \rightarrow 3$ in Fig. 3.11(b).

It is evident from Fig. 3.11 that $Q'_S > Q_S$. Therefore, the Diesel cycle efficiency is greater than the Otto cycle efficiency when both engines are built to withstand the same thermal and mechanical stresses.

2.8.4 Same Maximum Pressure and Heat Input

For same maximum pressure and same heat input the Otto cycle (12341) and Diesel cycle (12'3'4'1) are shown on p - V and T - s diagrams in Figs. 3.10(a) and 3.10(b) respectively.

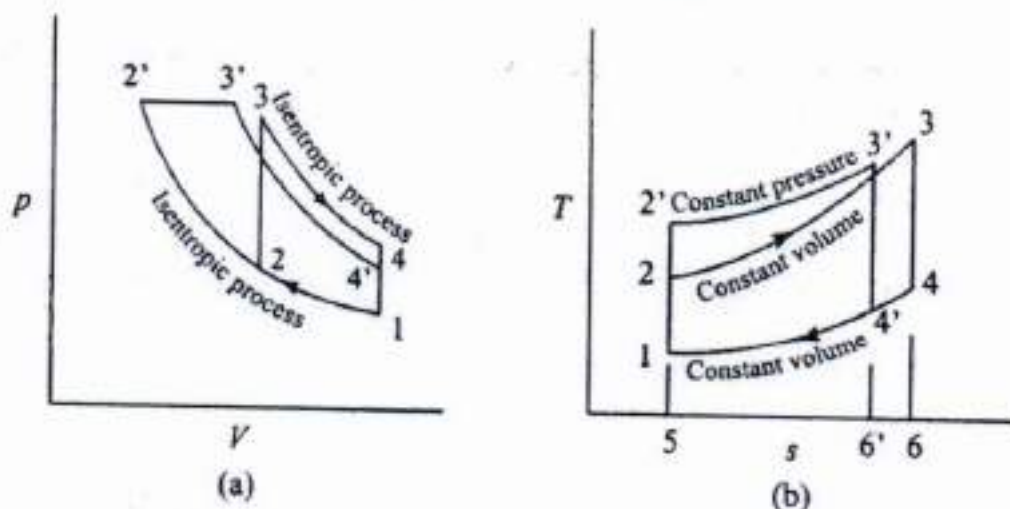

Fig. 3.10 Same Maximum Pressure and Heat Input

It is evident from the figure that the heat rejection for Otto cycle (area 1564 on T - s diagram) is more than the heat rejected in Diesel cycle (156'4'). Hence Diesel cycle is more efficient than Otto cycle for the condition of same maximum pressure and heat input. One can make a note that with these conditions the Diesel cycle has higher compression ratio $\frac{V_1}{V_2'}$ than that of Otto cycle $\frac{V_1}{V_2}$. One should also note that the cycle which is having higher efficiency allows maximum expansion. The Dual cycle efficiency will be between these two.

2.4.5 Same Maximum Pressure and Work Output

The efficiency, η , can be written as

$$\eta = \frac{\text{Work done}}{\text{Heat supplied}} = \frac{\text{Work done}}{\text{Work done} + \text{Heat rejected}}$$

Refer to T - s diagram in Fig. 3.12(b). For same work output the area 1234 (work output of Otto cycle) and area 12'3'4' (work output of Diesel cycle) are same. To achieve this, the entropy at 3 should be greater than entropy at 3'. It is clear that the heat rejection for Otto cycle is more than that of Diesel cycle. Hence, for these conditions the Diesel cycle is more efficient than the Otto cycle. The efficiency of Dual cycle lies between the two cycles.

2.7 THE LENOIR CYCLE

The Lenoir cycle consists of the following processes [see Fig. 2.14(a)]. Constant volume heat addition (1→2); isentropic expansion (2→3); constant pressure heat rejection (3→1). The Lenoir cycle is used for pulse jet engines.

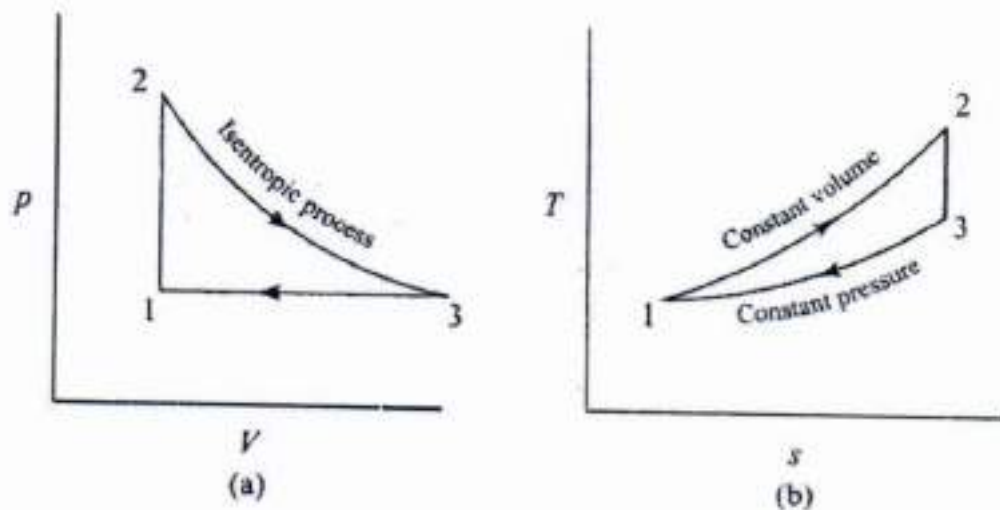

Fig. 2.14 Lenoir Cycle

$$\eta_{\text{Lenoir}} = \frac{Q_S - Q_F}{Q_S}$$

$$Q_S = mC_v(T_2 - T_1)$$

(3.15) 43

$$Q_R = mC_p(T_3 - T_1)$$

(3.16) 44

2.4.8 In an Otto cycle air at 17°C and 1 bar is compressed adiabatically until the pressure is 15 bar. Heat is added at constant volume until the pressure rises to 40 bar. Calculate the air-standard efficiency, the compression ratio and the mean effective pressure for the cycle. Assume $C_v = 0.717 \text{ kJ/kg K}$ and $R = 8.314 \text{ kJ/kmol K}$.

Solution

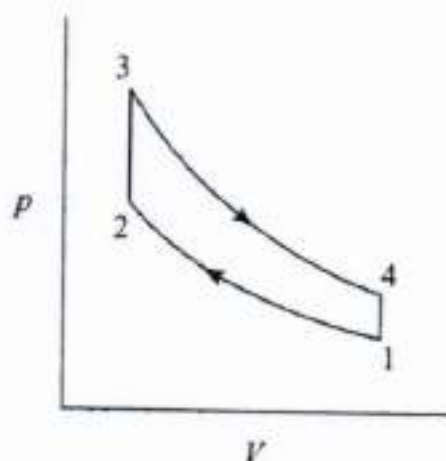

Consider the process 1 - 2

$$p_1 V_1^\gamma = p_2 V_2^\gamma$$

$$\frac{V_1}{V_2} = r = \left(\frac{p_2}{p_1}\right)^{\frac{1}{\gamma}}$$

$$= \left(\frac{15}{1}\right)^{\frac{1}{1.4}} = 6.91$$

$$\eta = 1 - \left(\frac{1}{r}\right)^{\gamma-1} = 1 - \left(\frac{1}{6.91}\right)^{0.4}$$

$$= 0.539 = \underline{\underline{53.9\%}} \quad \underline{\underline{\text{Ans}}}$$

$$T_2 = \frac{p_2 V_2}{p_1 V_1} T_1 = \frac{15}{1} \times \frac{1}{6.91} \times 290$$

$$= 629.5 \text{ K}$$

Consider the process 2 - 3

$$T_3 = \frac{p_3 T_2}{p_2} = \frac{40}{15} \times 629.5 = 1678.7$$

$$\begin{aligned}
 \text{Heat supplied} &= C_v(T_3 - T_2) \\
 &= 0.717 \times (1678.7 - 629.5) \\
 &= 752.3 \text{ kJ/kg}
 \end{aligned}$$

$$\begin{aligned}
 \text{Work done} &= \eta \times q_s \\
 &= 0.539 \times 752.3 = 405.5 \text{ kJ/kg}
 \end{aligned}$$

$$p_m = \frac{\text{Work done}}{\text{Swept volume}}$$

$$v_1 = \frac{V_1}{m} = M \frac{RT_1}{p_1}$$

$$= \frac{8314 \times 290}{29 \times 1 \times 10^5} = 0.8314 \text{ m}^3/\text{kg}$$

$$v_1 - v_2 = \frac{5.91}{6.91} \times 0.8314 = 0.711 \text{ m}^3/\text{kg}$$

$$p_m = \frac{405.5}{0.711} \times 10^3 = 5.70 \times 10^5 \text{ N/m}^2$$

$$= 5.70 \text{ bar} \quad \underline{\underline{\text{Ans}}}$$

21 Fuel supplied to an SI engine has a calorific value 42000 kJ/kg. The pressure in the cylinder at 30% and 70% of the compression stroke are 1.3 bar and 2.6 bar respectively. Assuming that the compression follows the law $pV^{1.3} = \text{constant}$. Find the compression ratio. If the relative efficiency of the engine compared with the air-standard efficiency is 50%. Calculate the fuel consumption in kg/kW h.

Solution

$$V_2 = 1$$

$$V_{1'} = 1 + 0.7(r - 1) = 0.7r + 0.3$$

$$V_{2'} = 1 + 0.3(r - 1) = 0.3r + 0.7$$

$$\frac{V_{1'}}{V_{2'}} = \left(\frac{p_2}{p_1}\right)^{\frac{1}{n}}$$

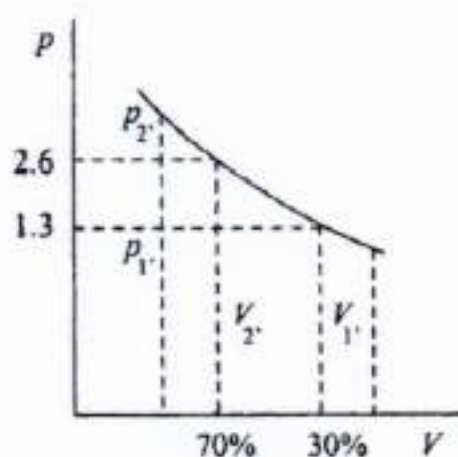

$$= \left(\frac{2.6}{1.3} \right)^{\frac{1}{1.3}} = 1.7$$

$$\frac{0.7r + 0.3}{0.3r + 0.7} = 1.7$$

$$r = 4.68 \quad \text{Ans}$$

$$\begin{aligned} \text{Air-standard efficiency} &= 1 - \frac{1}{r^{\gamma-1}} \\ &= 1 - \frac{1}{4.68^{0.4}} = 0.46 \\ &= 46\% \end{aligned}$$

$$\text{Relative efficiency} = \frac{\text{Indicated thermal efficiency}}{\text{Air-standard efficiency}}$$

$$\eta_{\text{th}} = 0.5 \times 0.46 = 0.23$$

$$\eta_{\text{th}} = \frac{ip}{CV \times \dot{m}}$$

where \dot{m} is in kg/s

$$\begin{aligned} \frac{\dot{m}}{ip} &= \frac{1}{42000 \times 0.23} \\ &= 1.035 \times 10^{-4} \text{ kg/kW s} \\ &= 1.035 \times 10^{-4} \times 3600 \text{ kg/kW h} \end{aligned}$$

$$isfc = 0.373 \text{ kg/kW h} \quad \text{Ans}$$

- 2.3. Determine the ideal efficiency of the diesel engine having a cylinder with bore 250 mm, stroke 375 mm and a clearance volume of 1500 cc, with fuel cut-off occurring at 5% of the stroke. Assume $\gamma = 1.4$ for air.

Solution

$$V_s = \frac{\pi}{4} d^2 L = \frac{\pi}{4} \times 25^2 \times 37.5$$

$$= 18407.8 \text{ cc}$$

$$r = 1 + \frac{V_s}{V_c} = 1 + \frac{18407.8}{1500} = 13.27$$

$$\eta = 1 - \frac{1}{r^{\gamma-1}} \frac{r_c^\gamma - 1}{\gamma(r_c - 1)}$$

Copyrighted material

$$r_c = \frac{V_3}{V_2}$$

$$\text{Cut-off volume} = V_3 - V_2 = 0.05V_s$$

$$= 0.05 \times 12.27V_c$$

$$V_2 = V_c$$

$$V_3 = 1.6135V_c$$

$$r_c = \frac{V_3}{V_2} = 1.6135$$

$$\eta = 1 - \frac{1}{13.27^{0.4}} \times \frac{1.6135^{1.4} - 1}{1.4 \times (1.6135 - 1)}$$

$$= 0.6052 = 60.52\%$$

Ans

- 2.4 In an engine working on Diesel cycle inlet pressure and temperature are 1 bar and 17 °C respectively. Pressure at the end of adiabatic compression is 35 bar. The ratio of expansion i.e. after constant pressure heat addition is 5. Calculate the heat addition, heat rejection and the efficiency of the cycle. Assume $\gamma = 1.4$, $C_p = 1.004$ kJ/kg K and $C_v = 0.717$ kJ/kg K.

Solution

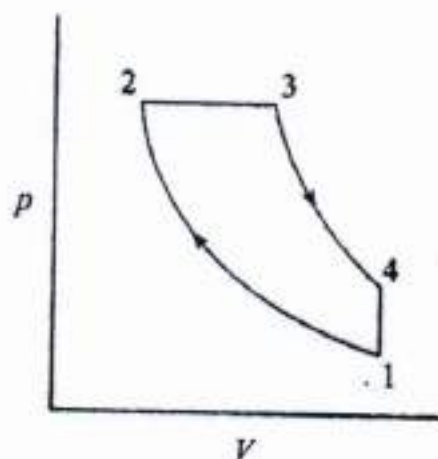

Consider the process 1 - 2

$$\frac{V_1}{V_2} = r = \left(\frac{p_2}{p_1}\right)^{\frac{1}{\gamma}}$$

$$\begin{aligned}
 &= \left(\frac{35}{1}\right)^{\frac{1}{1.4}} = 12.674 \\
 \text{Cut-off ratio} &= \frac{V_3}{V_2} = \frac{V_3}{V_1} \times \frac{V_1}{V_2} \\
 &= \frac{\text{Compression ratio}}{\text{Expansion ratio}} \\
 &= \frac{12.674}{5} = 2.535
 \end{aligned}$$

$$\begin{aligned}
 \frac{T_2}{T_1} &= \left(\frac{p_2}{p_1}\right)^{\frac{\gamma-1}{\gamma}} \\
 &= \left(\frac{35}{1}\right)^{0.286} = 2.76 \\
 T_2 &= 2.76 \times 290 = 801.7 \text{ K}
 \end{aligned}$$

Consider the process 2 - 3

$$\begin{aligned}
 T_3 &= T_2 \frac{V_3}{V_2} = 801.7 \times \frac{V_3}{V_2} \\
 &= 801.7 \times 2.535 = 2032.3 \text{ K}
 \end{aligned}$$

Consider the process 3 - 4

$$\begin{aligned}
 T_4 &= T_3 \left(\frac{V_3}{V_4}\right)^{\gamma-1} = 2032.3 \times \left(\frac{1}{5}\right)^{0.4} \\
 &= 1067.6 \text{ K}
 \end{aligned}$$

$$\begin{aligned}
 \text{Heat added} &= C_p(T_3 - T_2) = 1.004 \times (2032.3 - 801.7) \\
 &= 1235.5 \text{ kJ/kg} \quad \underline{\underline{\text{Ans}}}
 \end{aligned}$$

$$\begin{aligned}
 \text{Heat rejected} &= C_v(T_4 - T_1) = 0.717 \times (1067.6 - 290) \\
 &= 557.5 \text{ kJ/kg} \quad \underline{\underline{\text{Ans}}}
 \end{aligned}$$

$$\begin{aligned}
 \text{Efficiency} &= \frac{\text{Heat supplied} - \text{Heat rejected}}{\text{Heat supplied}} \\
 &= \frac{1235.5 - 557.5}{1235.5} = 0.549 \\
 &= 54.9\% \quad \underline{\underline{\text{Ans}}}
 \end{aligned}$$

- 2.15 A Diesel engine is working with a compression ratio of 15 and expansion ratio of 10. Calculate the air-standard efficiency of the cycle. Assume $\gamma = 1.4$.

Solution

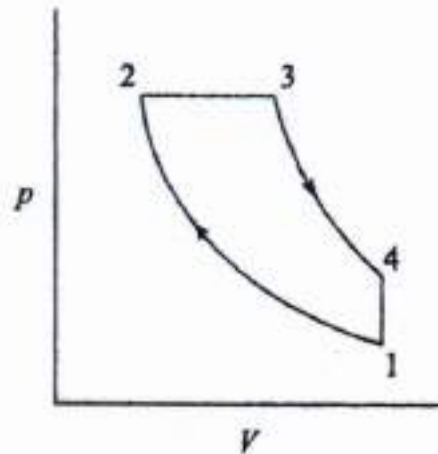

$$r = \frac{V_1}{V_2} = 15$$

$$r_e = \frac{V_4}{V_3} = 10$$

$$\eta = 1 - \frac{1}{\gamma} \frac{1}{r^{\gamma-1}} \left[\frac{\left(\frac{r}{r_e}\right)^\gamma - 1}{\left(\frac{r}{r_e}\right) - 1} \right]$$

$$= 1 - \frac{1}{1.4} \times \frac{1}{15^{0.4}} \times \left[\frac{\left(\frac{15}{10}\right)^{1.4} - 1}{\left(\frac{15}{10}\right) - 1} \right] = 0.63$$

$$= 63\%$$

Ans

2.25 An oil engine works on the Dual cycle, the heat liberated at constant pressure being twice that liberated at constant volume. The compression ratio of the engine is 8 and the expansion ratio is 5.3. But the compression and expansion processes follow the law $pV^{1.3} = C$. The pressure and temperature at the beginning of compression are 1 bar and 27°C respectively. Assuming $C_p = 1.004 \text{ kJ/kg K}$ and $C_v = 0.717 \text{ kJ/kg K}$ for air, find the air-standard efficiency and the mean effective pressure.

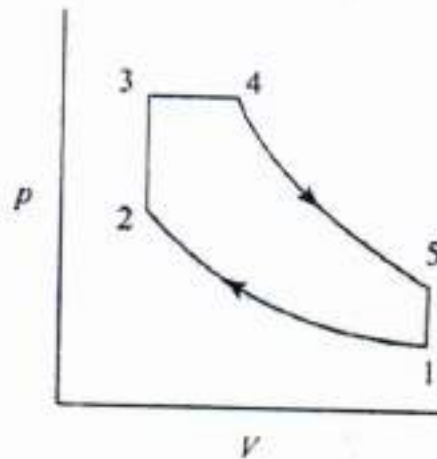

Solution

$$\gamma = \frac{C_p}{C_v} = \frac{1.004}{0.717} = 1.4$$

$$\frac{V_s}{V_c} = r - 1 = 7$$

$$V_s = 7V_c$$

$$r_e = \frac{r}{r_c} = 5.3$$

$$r_c = \frac{8}{5.3} = 1.509$$

$$\text{Mean effective pressure} = \frac{\text{Area 12345}}{V_s}$$

$$\text{Area 12345} = \text{Area under 3-4} +$$

$$\text{Area under 4-5} - \text{Area under 2-1}$$

~~2.25~~

$$\begin{aligned}
 &= p_3(V_3 - V_4) + \frac{p_4V_4 - p_5V_5}{n-1} - \frac{p_2V_2 - p_1V_1}{n-1} \\
 V_2 &= V_3 = V_c \\
 V_1 &= V_3 = rV_c = 8V_c \\
 V_4 &= r_cV_3 = 1.509V_c \\
 \frac{T_2}{T_1} &= r^{(n-1)} = 8^{0.3} = 1.866 \\
 T_2 &= 1.866 \times 300 = 559.82 \text{ K} \\
 \frac{p_2}{p_1} &= r^n = 8^{1.3} = 14.93 \\
 p_2 &= 14.93 \times p_1 = 14.93 \times 10^5 \text{ N/m}^2
 \end{aligned}$$

Heat released during constant pressure combustion

$$\begin{aligned}
 &= 2 \times \text{Heat released during constant volume combustion} \\
 C_p(T_4 - T_3) &= 2C_v(T_3 - T_2) \\
 1.004 \times (T_4 - T_3) &= 2 \times 0.717 \times (T_3 - T_2) \\
 T_4 - T_3 &= 1.428 \times (T_3 - T_2) \\
 \frac{T_4}{T_3} &= \frac{V_4}{V_3} = r_c = 1.509 \\
 T_4 &= 1.509 T_3 \\
 1.509 T_3 - T_3 &= 1.428 \times (T_3 - 559.82) \\
 T_3 &= 869.88 \text{ K} \\
 T_4 &= 1312.65 \text{ K} \\
 \frac{p_3}{p_2} &= \frac{T_3}{T_2} = \frac{869.88}{559.82} = 1.554 \\
 p_3 &= 1.554 \times 14.93 \times 10^5 \\
 &= 23.20 \times 10^5 \text{ N/m}^2 = p_4
 \end{aligned}$$

$$\frac{T_4}{T_5} = r_c^{(n-1)} = 5.3^{0.3} = 1.649$$

$$T_5 = \frac{1312.65}{1.649} = 796.03 \text{ K}$$

$$\frac{p_4}{p_5} = r_c^n = 5.3^{1.3} = 8.741$$

$$p_5 = \frac{p_4}{8.741} = \frac{23.2 \times 10^5}{8.741}$$

$$= 2.654 \times 10^5 \text{ N/m}^2$$

$$\begin{aligned} \text{Area 12345} &= \left[\frac{23.2 \times 1.509V_c - 2.654 \times 8V_c}{0.3} + \right. \\ &\quad \left. 23.2 \times (1.509V_c - V_c) - \frac{14.93 \times V_c - 1 \times 8V_c}{0.3} \right] \times 10^5 \end{aligned}$$

$$= 34.63 \times V_c \times 10^5 \text{ N/m}^2$$

$$V_c = \frac{V_1}{8}$$

$$\text{Area 12345} = p_m \times V_s = p_m \times 7 \times V_c$$

Therefore,

$$p_m = \frac{34.63}{7} = 4.95 \times 10^5 \text{ N/m}^2$$

$$= 4.95 \text{ bar}$$

Ans

$$\eta = \frac{w}{q_s}$$

$$v_1 = \frac{mRT_1}{p_1} = \frac{1 \times 287 \times 300}{1 \times 10^5}$$

$$= 0.861 \text{ m}^3/\text{kg}$$

$$w = 34.63 \times 10^5 \times \frac{v_1}{8}$$

$$= 34.63 \times 10^5 \times \frac{0.861}{8}$$

$$= 3.727 \times 10^5 \text{ J/kg} = 372.7 \text{ kJ/kg}$$

Note : Work done should be calculated only from the area ($\int p dv$) for a polytropic process

$$\begin{aligned} q_s &= q(T_3 - T_2) + C_p(T_4 - T_3) \\ &= 667.1 \text{ kJ/kg} \end{aligned}$$

$$\eta = \frac{372.7}{667.1} \times 100 = 55.9\% \quad \underline{\underline{\text{Ans}}}$$

~~COMPARISON OF CYCLES~~

27 A four-cylinder, four-stroke, spark-ignition engine has a displacement volume of 300 cc per cylinder. The compression ratio of the engine is 10 and operates at a speed of 3000 rev/min. The engine is required to develop an output of 40 kW at this speed. Calculate the cycle efficiency, the necessary rate of heat addition, the mean effective pressure and the maximum temperature of the cycle. Assume that the engine operates on the Otto cycle and that the pressure and temperature at the inlet conditions are 1 bar and 27 °C respectively. If the above engine is a compression-ignition engine operating on the Diesel cycle and receiving heat at the same rate, calculate efficiency, the maximum temperature of the cycle, the cycle efficiency, the power output and the mean effective pressure. Take $C_v = 0.717 \text{ kJ/kg K}$ and $\gamma = 1.4$.

Solution

Consider the Otto cycle, Fig.3.9(a)

$$\begin{aligned} \eta &= 1 - \frac{1}{r^{\gamma-1}} \\ &= 1 - \frac{1}{10^{0.4}} = 0.602 \\ &= 60.2\% \quad \underline{\underline{\text{Ans}}} \end{aligned}$$

$$\eta = \frac{\text{Power output}}{\text{Heat supplied}}$$

$$\text{Heat supplied} = \frac{40}{0.602} = 66.5 \text{ kW}$$

$$= 66.5 \text{ kJ/s} \quad \underline{\underline{\text{Ans}}}$$

$$\text{Number of cycles/sec} = \frac{3000}{2 \times 60} = 25$$

Net work output per cycle from each cylinder

$$= \frac{40}{4 \times 25} = 0.4 \text{ kJ}$$

$$p_m = \frac{W}{V_s} = \frac{0.4 \times 1000}{300 \times 10^{-6}}$$

$$= 13.3 \times 10^5 \text{ N/m}^2 \quad \underline{\underline{\text{Ans}}}$$

$$T_2 = T_1 \left(\frac{V_1}{V_2} \right)^{\gamma-1}$$

$$= 300 \times 10^{0.4} = 753.6 \text{ K}$$

Heat supplied/cylinder/cycle (Q_{2-3})

$$= \frac{66.5}{4 \times 25} = 0.665 \text{ kJ}$$

Now,

$$Q_{2-3} = mC_v(T_3 - T_2)$$

$$v_1 = \frac{RT_1}{p_1} = \frac{287 \times 300}{1 \times 10^5}$$

$$= 0.861 \text{ m}^3/\text{kg}$$

This initial volume of air in the cylinder is

$$V_1 = V_2 + V_s = \left(\frac{V_1}{10} \right) + V_s$$

$$0.9V_1 = V_s$$

$$V_1 = \frac{V_s}{0.9} = \frac{300 \times 10^{-6}}{0.9}$$

$$= 333 \times 10^{-6} \text{ m}^3$$

$$m = \frac{V_1}{v_1} = \frac{333 \times 10^{-6}}{0.861}$$

$$= 0.387 \times 10^{-3} \text{ kg}$$

The temperature rise resulting from heat addition is

$$\begin{aligned}
 T_3 - T_2 &= \frac{Q_{2-3}}{m C_v} \\
 &= \frac{0.665}{0.387 \times 10^{-3} \times 0.717} \\
 &= 2396.6 \text{ K} \\
 T_3 &= T_2 + 2396.6 = 753.6 + 2396.6 \\
 &= 3150.2 \text{ K} = 2877^\circ \text{ C} \quad \underline{\underline{\text{Ans}}}
 \end{aligned}$$

Now let us consider the Diesel cycle

T_2 is the same as in the previous case, i.e.

$$T_2 = 753.6$$

Heat supplied per cycle per cylinder is also same, i.e.

$$\begin{aligned}
 Q_{2-3'} &= 0.665 \text{ kJ} \\
 Q_{2-3'} &= m C_p (T_{3'} - T_2) \\
 T_{3'} - T_2 &= \frac{0.665}{0.387 \times 10^{-3}} \times \frac{1}{1.004} \\
 &= 1711.5 \text{ K}
 \end{aligned}$$

$$\begin{aligned}
 T_{3'} &= 1711.5 + 753.6 = 2465.1 \text{ K} \\
 &= 2192.1^\circ \text{ C} \quad \underline{\underline{\text{Ans}}}
 \end{aligned}$$

$$\begin{aligned}
 \text{Cut-off ratio, } r_c &= \frac{V_3}{V_2} = \frac{T_{3'}}{T_2} \\
 &= \frac{2465.1}{753.6} = 3.27
 \end{aligned}$$

$$\begin{aligned}
 \text{Air-standard efficiency} &= 1 - \frac{1}{r^{\gamma-1}} \left[\frac{r_c^\gamma - 1}{\gamma (r_c - 1)} \right] \\
 &= 1 - \frac{1}{10^{0.4}} \times \left[\frac{3.27^{1.4} - 1}{1.4 \times (3.27 - 1)} \right] \\
 &= 1 - 0.398 \times 1.338 = 0.467 \\
 &= 46.7\% \quad \underline{\underline{\text{Ans}}}
 \end{aligned}$$

$$\begin{aligned} \text{Power output} &= \eta \times \text{total rate of heat added} \\ &= 0.467 \times 66.5 = 31.1 \text{ kW} \end{aligned}$$

$$\text{Power output/cylinder} = \frac{31.1}{4} = 7.76 \text{ kW}$$

Work done/cylinder/cycle

$$= \frac{7.76}{25} = 0.3104 \text{ kJ}$$

$$P_m = \frac{W}{V_s} = \frac{0.3104 \times 1000}{300 \times 10^{-6}}$$

$$= 10.35 \times 10^5 \text{ N/m}^2 \quad \underline{\underline{\text{Ans}}}$$

As discussed in the text, this problem illustrates that for the same compression ratio and heat input Otto cycle is more efficient.

CHAPTER THREE

FUEL-AIR CYCLES AND THEIR ANALYSIS

3.1 INTRODUCTION

In the previous chapter, a detailed discussion of air-standard cycles, particularly for IC engines has been given. The analysis was based on highly simplifying assumptions. Because of this, the estimated engine performance by air-standard cycle analysis is on the higher side compared to the actual performance. For example, the actual indicated thermal efficiency of an SI engine, say with a compression ratio of 8:1, is of the order of 28% whereas the air-standard efficiency is 56.5%. This large deviation may to some extent be attributed to progressive burning of the fuel, incomplete combustion and valve operation etc. However, the main reasons for this may be attributed to the over simplified assumptions made in the analysis.

In an actual engine, the working fluid is a mixture of air, fuel vapour and residual gases from the previous cycle. Further, the specific heats of the working fluid are not constant but increase with temperature. Finally, the products of combustion are subjected to a certain dissociation at high temperatures. If the actual physical properties of the gases in the cylinder before and after the combustion are taken into account, a reasonably close values to the actual pressures and temperatures existing within the engine cylinder can be estimated. The mean effective pressures and efficiencies, calculated by this analysis, in the case of well designed engines are higher only by a few per cent from the actual values obtained by tests. The analysis based on the actual properties of the working medium viz., fuel and air is called the fuel-air cycle analysis and even this analysis has simplifying assumptions. However, they are more justifiable and close to the actual conditions than those used in the air-standard cycle analysis.

3.2 FUEL-AIR CYCLES AND THEIR SIGNIFICANCE

By air-standard cycle analysis, it is understood how the efficiency is improved by increasing the compression ratio. However, analysis cannot bring

out the effect of air-fuel ratio on the thermal efficiency because the working medium was assumed to be air. In this chapter, the presence of fuel in the cylinder is taken into account and accordingly the working medium will be a mixture of fuel and air. By fuel-air cycle analysis it will be possible to bring out the effect of fuel-air ratio on thermal efficiency and also study how the peak pressures and temperatures during the cycle vary with respect to fuel-air ratio. In general, influence of many of the engine operating variables on the pressures and temperatures within the engine cylinder may be better understood by the examination of the fuel-air cycles. The fuel-air cycle analysis takes into account the following :

- (i) *The actual composition of the cylinder gases* : The cylinder gases contains fuel, air, water vapour and residual gas. The fuel-air ratio changes during the operation of the engine which changes the relative amounts of CO_2 , water vapour, etc.
- (ii) *The variation in the specific heat with temperature* : Specific heats increase with temperature except for mono-atomic gases. Therefore, the value of γ also changes with temperature.
- (iii) *The effect of dissociation* : The fuel and air do not completely combine chemically at high temperatures (above 1600 K) and this leads to the presence of CO , H_2 , H and O_2 at equilibrium conditions.
- (iv) *The variation in the number of molecules* : The number of molecules present after combustion depend upon fuel-air ratio and upon the pressure and temperature after the combustion.

Besides taking the above factors into consideration, the following assumptions are commonly made :

- (i) There is no chemical change in either fuel or air prior to combustion.
- (ii) Subsequent to combustion, the charge is always in chemical equilibrium.
- (iii) There is no heat exchange between the gases and the cylinder walls in any process, i.e. they are adiabatic. Also the compression and expansion processes are frictionless.
- (iv) In case of reciprocating engines it is assumed that fluid motion can be ignored inside the cylinder.

With particular reference to constant-volume fuel-air cycle, it is also assumed that

- (v) The fuel is completely vaporized and perfectly mixed with the air, and
- (vi) The burning takes place instantaneously at top dead centre (at constant volume).

As already mentioned, the air-standard cycle analysis shows the general effect of only compression ratio on engine efficiency whereas the fuel-air cycle analysis gives the effect of variation of fuel-air ratio, inlet pressure and temperature on the engine performance. It will be noticed that compression ratio and fuel-air ratio are very important parameters of the engine while inlet conditions are not so important.

The actual efficiency of a good engine is about 85 per cent of the estimated fuel-air cycle efficiency. A good estimate of the power to be expected from the actual engine can be made from fuel-air cycle analysis. Also, peak pressures and exhaust temperatures which affect the engine structure and design can be estimated reasonably close to an actual engine. Thus the effect of many variables on the performance of an engine can be understood better by fuel-air cycle analysis.

3.3 COMPOSITION OF CYLINDER GASES

The air-fuel ratio changes during the engine operation. This change in air-fuel ratio affects the composition of the gases before combustion as well as after combustion particularly the percentage of carbon dioxide, carbon monoxide, water vapour etc in the exhaust gases.

In four-stroke engines, fresh charge as it enters the engine cylinder, comes into contact with the burnt gases left in the clearance space of the previous cycle. The amount of exhaust gases in clearance space varies with speed and load on the engine. Fuel-air cycle analysis takes into account this fact and the results are computed for preparing the combustion charts. However, with the availability of fast digital computers, nowadays it is possible to analyze the effect of cylinder gas composition on the performance of the engine by means of suitable numerical techniques. The computer analysis can produce fast and accurate results. Thus, fuel-air cycle analysis can be done more easily through computers rather than through manual calculations.

3.4 VARIABLE SPECIFIC HEATS

All gases, except mono-atomic gases, show an increase in specific heat with temperature. The increase in specific heat does not follow any particular law. However, over the temperature range generally encountered for gases in heat engines (300 K to 2000 K) the specific heat curve is nearly a straight line which may be approximately expressed in the form

$$\left. \begin{aligned} C_p &= a_1 + k_1 T \\ C_v &= b_1 + k_1 T \end{aligned} \right\} \quad (3.1)$$

where a_1, b_1 and k_1 are constants. Now,

$$R = C_p - C_v = a_1 - b_1 \quad (3.2)$$

where R is the characteristic gas constant.

Above 1500 K the specific heat increases much more rapidly and may be expressed in the form

$$C_p = a_1 + k_1T + k_2T^2 \quad (4.3)$$

$$C_v = b_1 + k_1T + k_2T^2 \quad (4.4)$$

In Eqn. 4.4 if the term T^2 is neglected it becomes same as Eqn. 4.1. Many expressions are available even upto sixth order of T (i.e. T^6) for the calculation of C_p and C_v .

The physical explanation for increase in specific heat is that as the temperature is raised, larger fractions of the heat would be required to produce motion of the atoms within the molecules. Since temperature is the result of motion of the molecules, as a whole, the energy which goes into moving the atoms does not contribute to proportional temperature rise. Hence, more heat is required to raise the temperature of unit mass through one degree at higher levels. This heat by definition is the specific heat. For air, the values are

$$C_p = 1.005 \text{ kJ/kg K at } 300 \text{ K} \quad C_v = 0.717 \text{ kJ/kg K at } 300 \text{ K}$$

$$C_p = 1.345 \text{ kJ/kg K at } 2000 \text{ K} \quad C_v = 1.057 \text{ kJ/kg K at } 2000 \text{ K}$$

Since the difference between C_p and C_v is constant, the value of γ decreases with increase in temperature. Thus, if the variation of specific heats is taken into account during the compression stroke, the final temperature and pressure would be lower than if constant values of specific heat are used. This point is illustrated in Fig. 3.1.

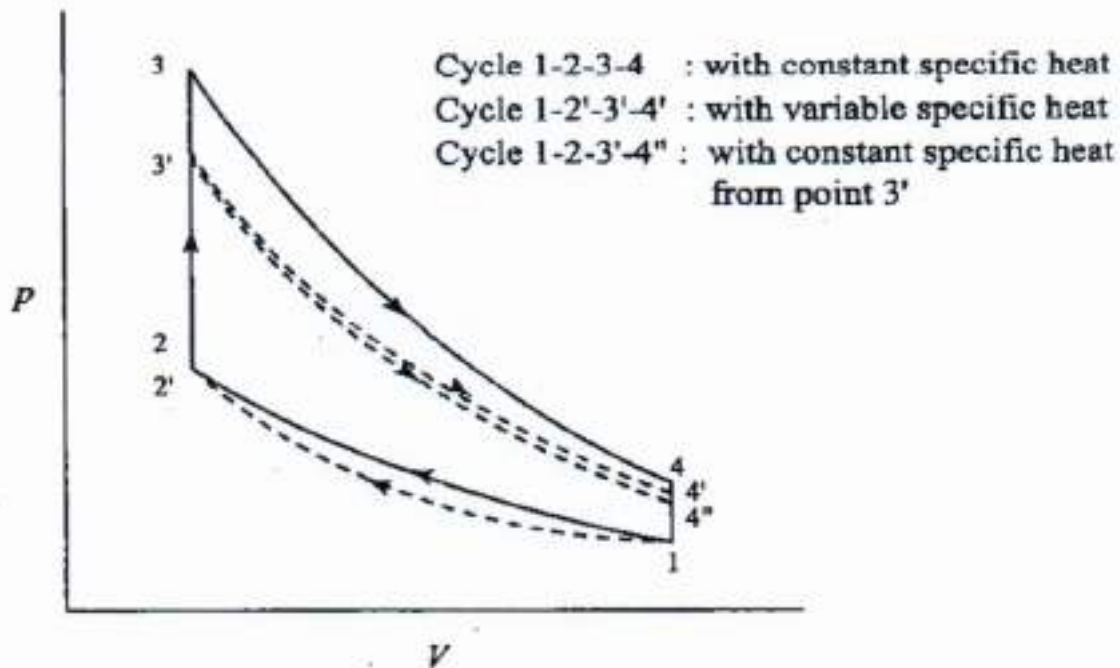

Fig. 3.1 Loss of Power due to Variation of Specific Heat

With variable specific heats, the temperature at the end of compression will be $2'$, instead of 2 . The magnitude of drop in temperature is proportional to the drop in the value of ratio of specific heats. For the process $1 \rightarrow 2$, with constant specific heats

$$T_2 = T_1 \left(\frac{v_1}{v_2} \right)^{\gamma-1} \quad (4.5)$$

with variable specific heats,

$$T_{2'} = T_1 \left(\frac{v_1}{v_{2'}} \right)^{k-1} \quad (4.6)$$

where $k = \frac{C_p}{C_v}$. Note that $v_{2'} = v_2$ and $v_1/v_2 = v_1/v_{2'} = r$.

For given values of T_1, p_1 and r , the magnitude of $T_{2'}$ depends on k . Constant volume combustion, from point $2'$ will give a temperature $T_{3'}$ instead of T_3 . This is due to the fact that the rise in the value of C_v because of variable specific heat, which reduces the temperature as already explained.

The process, $2' \rightarrow 3'$ is heat addition with the variation in specific heat. From $3'$, if expansion takes place at constant specific heats, this would result in the process $3' \rightarrow 4''$ whereas actual expansion due to variable specific heat will result in $3' \rightarrow 4'$ and $4'$ is higher than $4''$. The magnitude in the difference between $4'$ and $4''$ is proportional to the reduction in the value of γ .

Consider the process $3'4''$

$$T_{4''} = T_{3'} \left(\frac{v_3}{v_4} \right)^{(k-1)} \quad (4.7)$$

for the process $3'4'$

$$T_{4'} = T_{3'} \left(\frac{v_3}{v_4} \right)^{(\gamma-1)} \quad (4.8)$$

Reduction in the value of k due to variable specific heat results in increase of temperature from $T_{4''}$ to $T_{4'}$.

3.5 DISSOCIATION

Dissociation process can be considered as the disintegration of combustion products at high temperature. Dissociation can also be looked as the reverse process to combustion. During dissociation the heat is absorbed whereas during combustion the heat is liberated. In IC engines, mainly dissociation of CO_2 into CO and O_2 occurs, whereas there is a very little dissociation of H_2O .

The dissociation of CO_2 into CO and O_2 starts commencing around 1000°C and the reaction equation can be written as



Similarly, the dissociation of H_2O occurs at temperatures above $1300\text{ }^\circ\text{C}$ and is written as



The presence of CO and O_2 in the gases tends to prevent dissociation of CO_2 ; this is noticeable in a rich fuel mixture, which, by producing more CO , suppresses dissociation of CO_2 . On the other hand, there is no dissociation in the burnt gases of a lean fuel-air mixture. This is mainly due to the fact that the temperature produced is too low for this phenomenon to occur. Hence, the maximum extent of dissociation occurs in the burnt gases of the chemically correct fuel-air mixture when the temperatures are expected to be high but decreases with the leaner and richer mixtures.

In case of internal combustion engines heat transfer to the cooling medium causes a reduction in the maximum temperature and pressure. As the temperature falls during the expansion stroke the separated constituents recombine; the heat absorbed during dissociation is thus again released, but it is too late in the stroke to recover entirely the lost power. A portion of this heat is carried away by the exhaust gases.

Figure 3.2 shows a typical curve that indicates the reduction in the temperature of the exhaust gas mixtures due to dissociation with respect to air-fuel ratio. With no dissociation maximum temperature is attained at chemically correct air-fuel ratio. With dissociation maximum temperature is obtained when mixture is slightly rich. Dissociation reduces the maximum temperature by about $300\text{ }^\circ\text{C}$ even at the chemically correct air-fuel ratio. In the Fig 3.2, lean mixtures and rich mixtures are marked clearly.

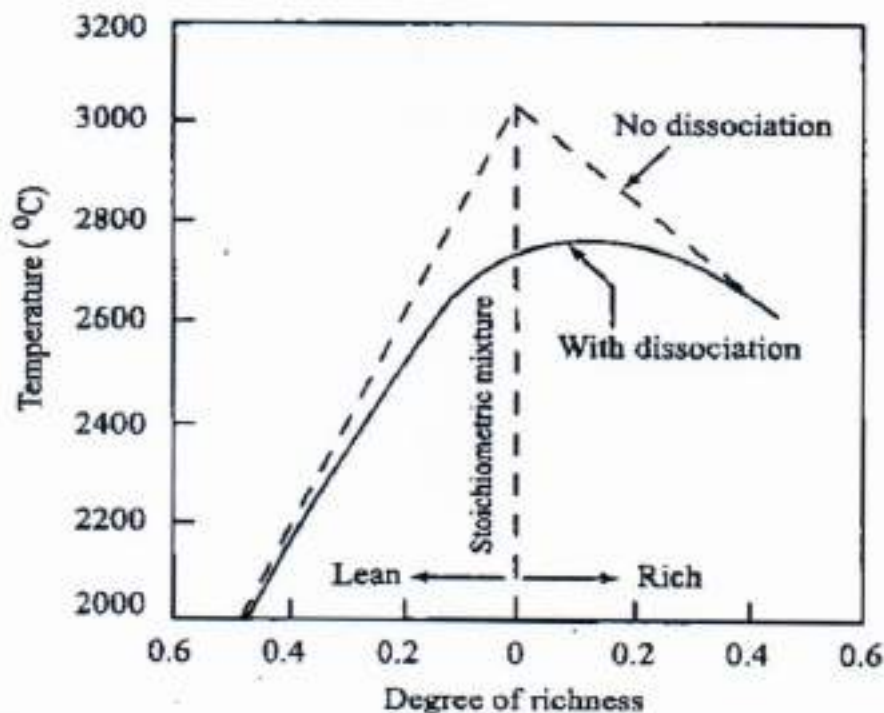

Fig. 3.2 Effect of Dissociation on Temperature

The effect of dissociation on output power is shown in Fig. 3.3 for a typical four-stroke spark-ignition engine operating at constant speed. If there is no dissociation, the brake power output is maximum when the mixture ratio is stoichiometric. The shaded area between the brake power graphs shows the loss of power due to dissociation. When the mixture is quite lean there is no dissociation. As the air-fuel ratio decreases i.e., as the mixture becomes rich the maximum temperature rises and dissociation commences. The maximum dissociation occurs at chemically correct mixture strength. As the mixture becomes richer, dissociation effect tends to decline due to incomplete combustion.

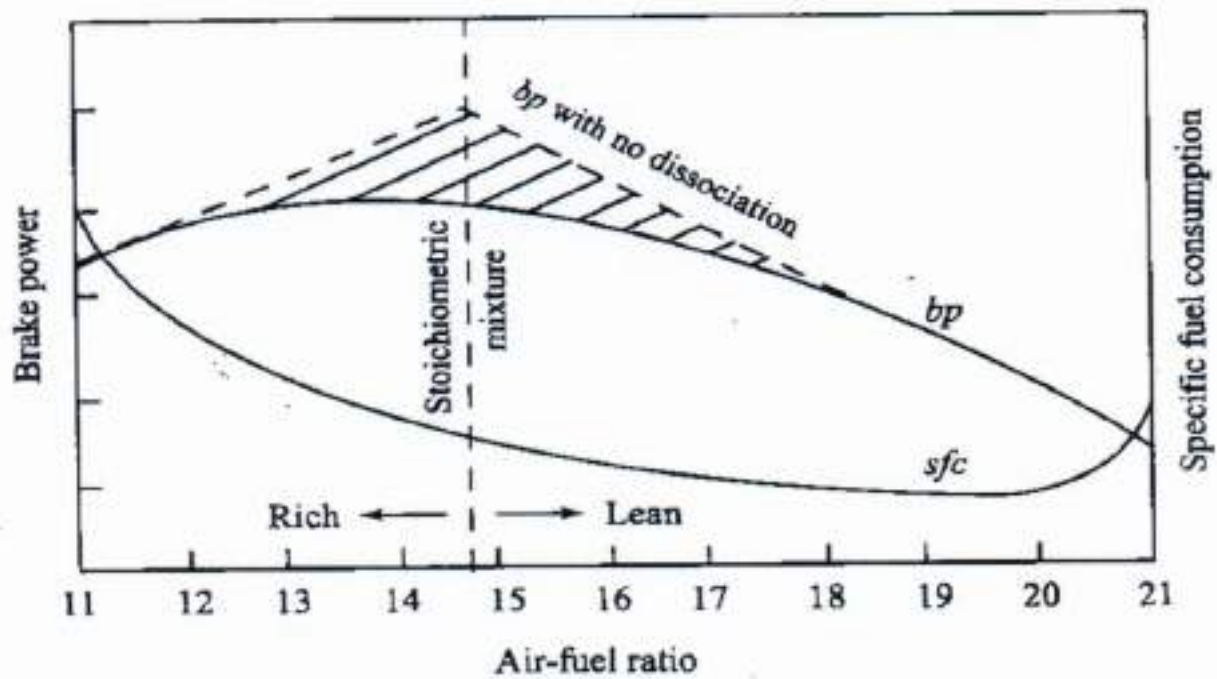

Fig. 3.3 Effect of Dissociation on Power

Dissociation effects are not so pronounced in a CI engine as in an SI engine. This is mainly due to

- (i) the presence of a heterogeneous mixture and
- (ii) excess air to ensure complete combustion.

Both these factors tend to reduce the peak gas temperature attained in the CI engine.

Figure 3.4 shows the effect of dissociation on p - V diagram of Otto cycle. Because of lower maximum temperature due to dissociation the maximum pressure is also reduced and the state after combustion will be represented by 3' instead of 3. If there was no reassociation due to fall of temperature during expansion the expansion process would be represented by 3'→4'' but due to reassociation the expansion follows the path 3'→4'. By comparing with the ideal expansion 3→4, it is observed that the effect of dissociation is to lower the temperature and consequently the pressure at the beginning

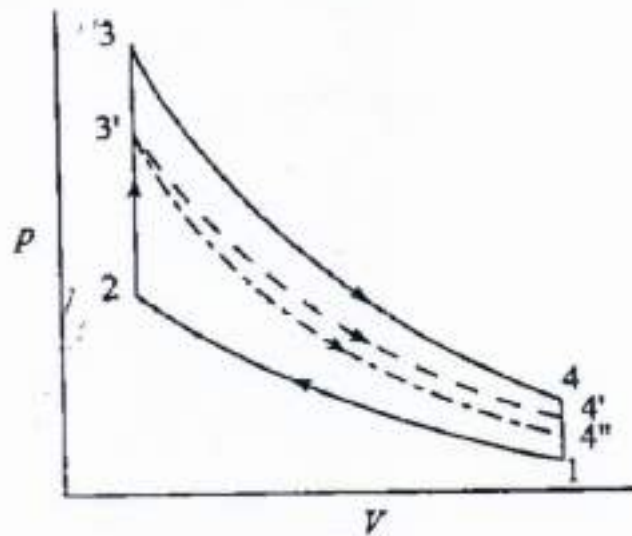

Fig. 3.4 Effect of Dissociation shown on a p - V Diagram

of the expansion stroke. This causes a loss of power and also efficiency. Though during recombining the heat is given back it is too late to contribute a convincing positive increase in the output of the engine.

3.6 EFFECT OF NUMBER OF MOLES

As already mentioned the number of molecules present in the cylinder after combustion depends upon the fuel-air ratio, type and extent of reaction in the cylinder. According to the gas law

$$pV = N\bar{R}T$$

the pressure depends on the number of molecules or moles present. This has direct effect on the amount of work the cylinder gases can impart on the piston.

3.7 COMPARISON OF AIR-STANDARD AND FUEL-AIR CYCLES

In this section reasons for difference between air-standard cycles and fuel-air cycles is discussed. The magnitude of difference between the two cycles can be attributed to the following factors :

- (i) character of the cycle (due to assumptions)
- (ii) equivalence ratio (actual $F/A \div$ stoichiometric F/A)
- (iii) chemical composition of the fuel

Figure 3.5 shows variation of efficiency with mixture strength of fuel-air cycle relative to that of air cycle showing the gain in efficiency as the mixture becomes leaner. It is seen from Fig. 3.5 that the efficiency ratio (fuel-air

cycle efficiency/air-standard cycle efficiency) increases as the mixture becomes leaner and leaner tending towards the air-standard cycle efficiency. It is to be noted that this, trend exists at all compression ratios.

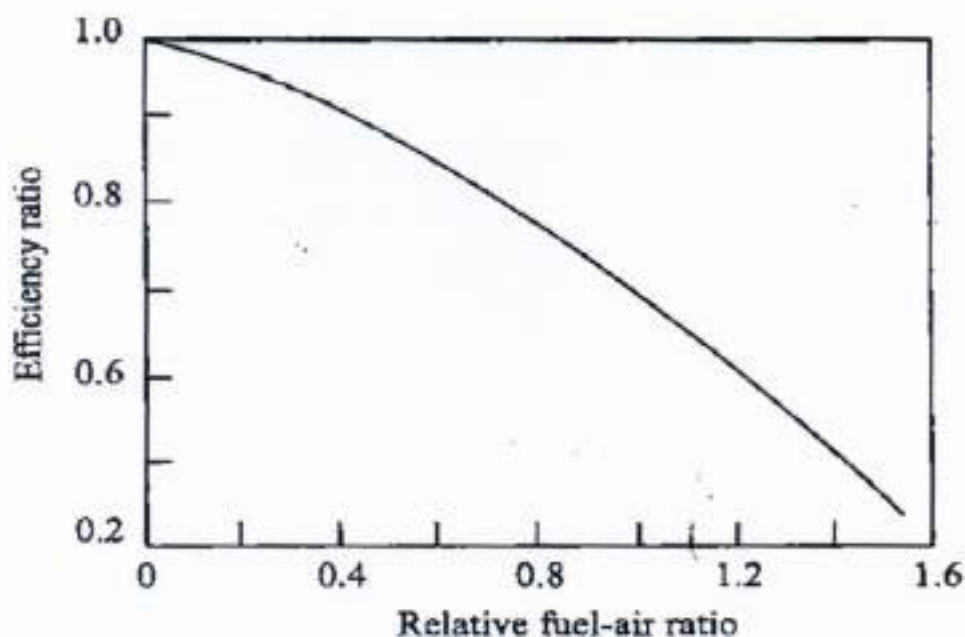

Fig. 3.5 Effect of Relative Fuel-Air ratio on Efficiency Ratio

At very low fuel-air ratio the mixture would tend to behave like a perfect gas with constant specific heat. Cycles with lean to very lean mixtures tend towards air-standard cycles. In such cycles the pressure and temperature rises. Some of the chemical reactions involved tend to be more complete as the pressure increases. These considerations apply to constant-volume as well as constant-pressure cycles.

The simple air-standard cycle analysis cannot predict the variation of thermal efficiency with mixture strength since air is assumed to be the working medium. However, fuel-air cycle analysis suggests that the thermal efficiency will deteriorate as the mixture supplied to an engine is enriched. This is explained by the increasing losses due to variable specific heats and dissociation as the mixture strength approaches chemically correct values. This is because, the gas temperature goes up after combustion as the mixture strength approaches chemically correct values. Enrichment beyond the chemically correct ratio will lead to incomplete combustion and loss in thermal efficiency. Therefore, it will appear that thermal efficiency will increase as the mixture is made leaner. However, beyond a certain leaning, the combustion becomes erratic with loss of efficiency. Thus the maximum efficiency is within the lean zone very near the stoichiometric ratio. This gives rise to combustion loop, as shown in Fig. 3.6 which can be plotted for different mixture strengths for an engine running at constant speed and at a constant throttle setting. This loop gives an idea about the effect of mixture strength on the specific fuel consumption.

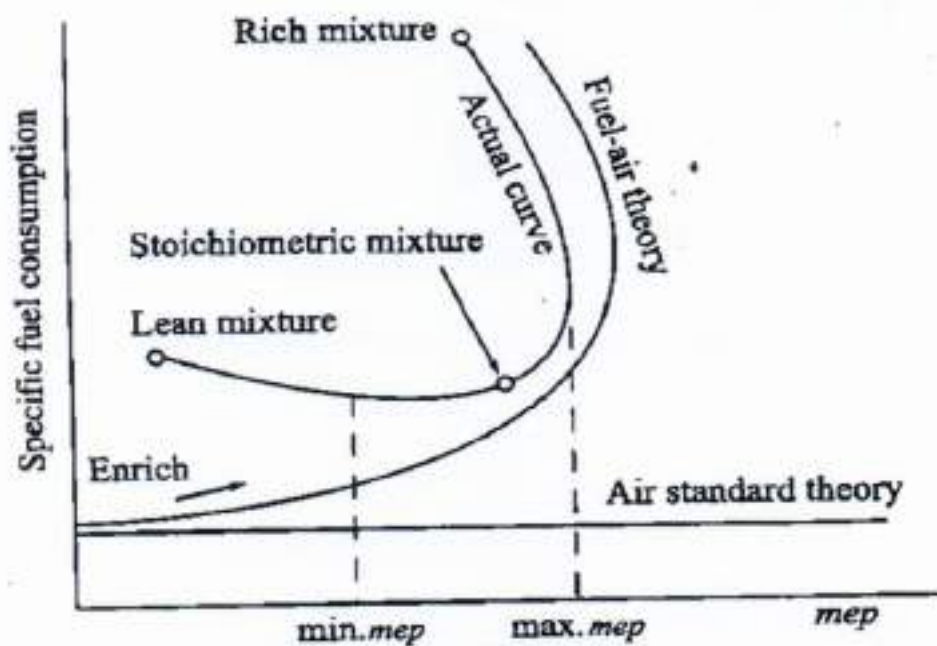

Fig. 3.6 Specific Fuel Consumption vs Mean Effective Pressure at Constant Speed and Constant Throttle Setting

3.8 EFFECT OF OPERATING VARIABLES

The effect of the common engine operating variables on the pressure and temperature within the engine cylinder is better understood by fuel-air cycle analysis. The details are discussed in the following sections.

3.8.1 Compression Ratio

The fuel-air cycle efficiency increases with the compression ratio in the same manner as the air-standard cycle efficiency, principally for the same reason (more scope of expansion work). This is shown in Fig 3.7.

The variation of indicated thermal efficiency with respect to the equivalence ratio for various compression ratios is given in Fig 3.8. The equivalence ratio, ϕ , is defined as ratio of actual fuel-air ratio to chemically correct fuel-air ratio on mass basis. The maximum pressure and maximum temperature increase with compression ratio since the temperature, T_2 , and pressure, p_2 , at the end of compression are higher. However, it can be noted from the experimental results (Fig 3.9) that the ratio of fuel-air cycle efficiency to air-standard efficiency is independent of the compression ratio for a given equivalence ratio for the constant-volume fuel-air cycle.

3.8.2 Fuel-Air Ratio

- (i) *Efficiency* : As the mixture is made lean (less fuel) the temperature rise due to combustion will be lowered as a result of reduced energy input per unit mass of mixture. This will result in lower specific

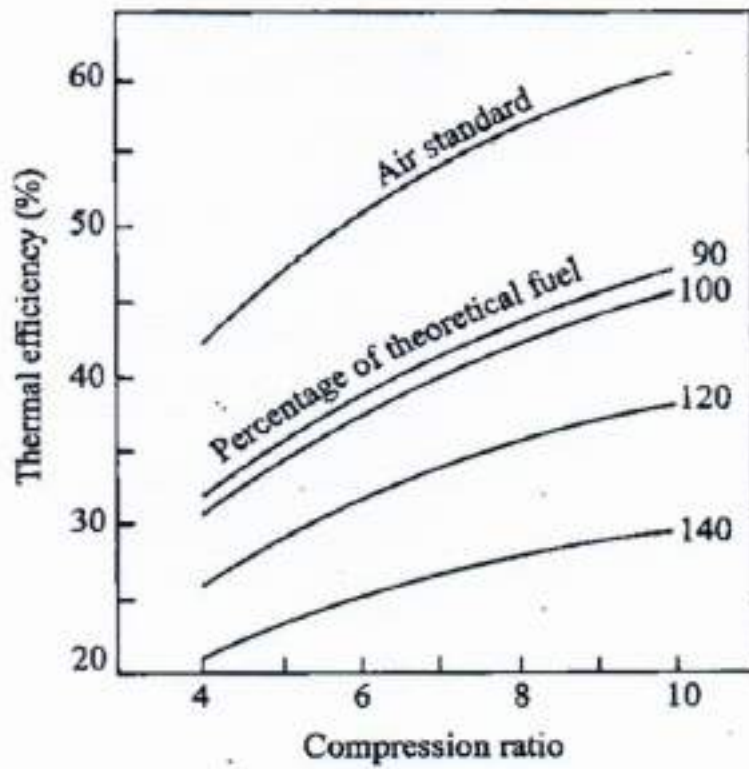

Fig. 3.7 Effect of Compression Ratio and Mixture Strength on Efficiency

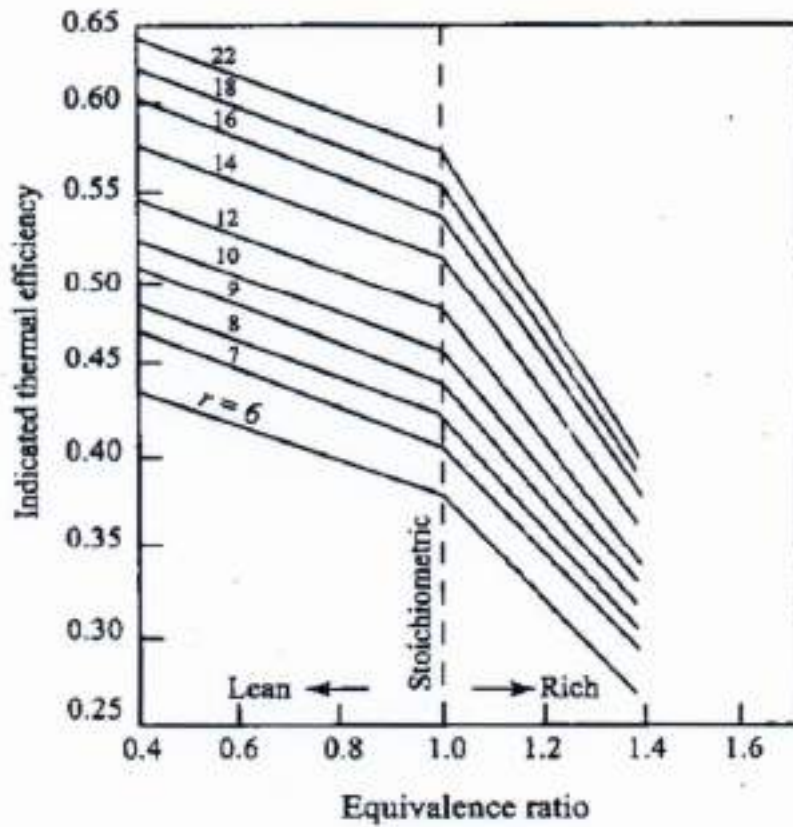

Fig. 3.8 Effect of Mixture Strength on Thermal Efficiency for Various Compression Ratios

heat. Further, it will lower the losses due to dissociation and variation in specific heat. The efficiency is therefore, higher and, in fact, approaches the air-cycle efficiency as the fuel-air ratio is reduced as shown in Fig 3.10.

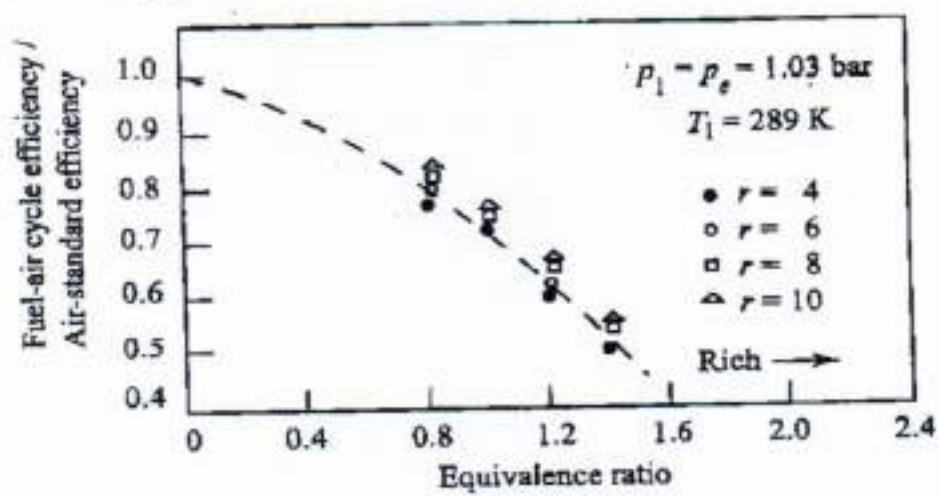

Fig. 3.9 Variation of Efficiency with Mixture Strength for a Constant Volume Fuel-Air Cycle

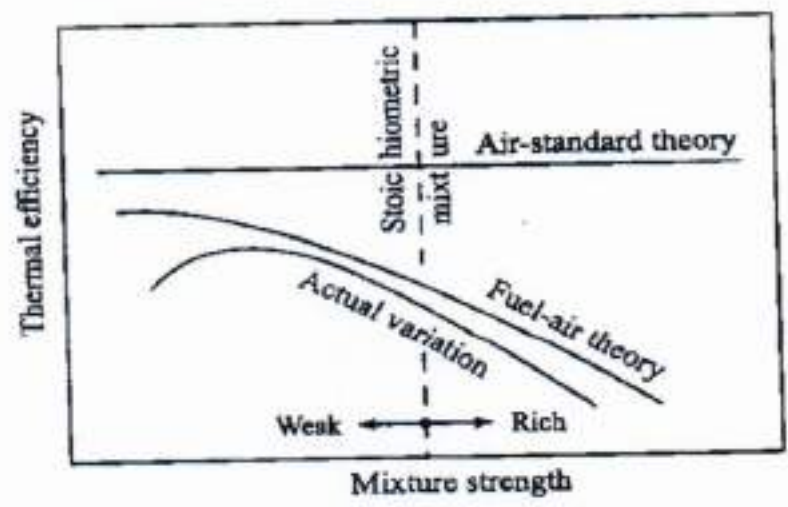

Fig. 3.10 Effect of Mixture Strength on Thermal Efficiency

(ii) **Maximum Power** : Fuel-air ratio affects the maximum power output of the engine. The variation is as shown in Fig 3.11. As the mixture becomes richer, after a certain point both efficiency and power output falls as can be seen from the experimental curve (Figs 3.10 and 3.11). This is because in addition to higher specific heats and chemical equilibrium losses, there is insufficient air which will result in formation of CO and H₂ during combustion, which represents a direct wastage of fuel. However, fuel-air cycle analysis cannot exactly imitate the experimental curve due to various simplifying assumptions made.

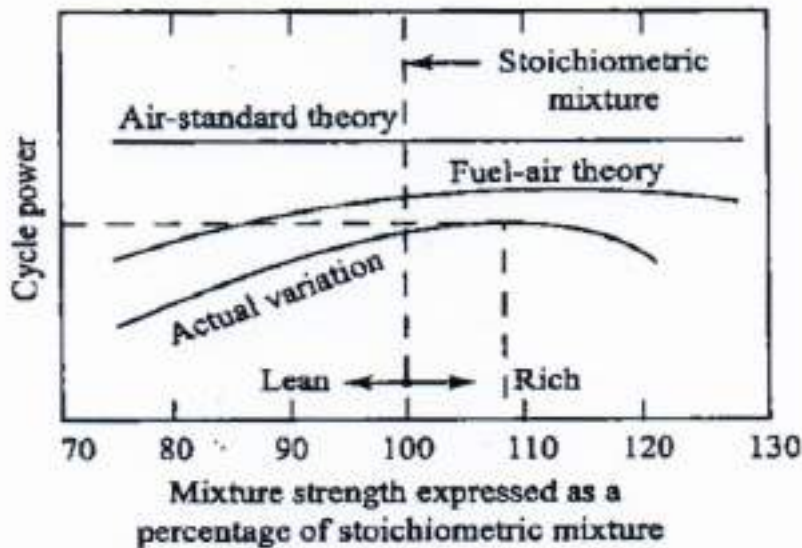

Fig. 3.11 Effect of Fuel-Air Ratio on Power

- (iii) *Maximum temperature* : At a given compression ratio the temperature after combustion reaches a maximum when the mixture is slightly rich, i.e., around 6% or so ($F/A = 0.072$ or $A/F = 14 : 1$) as shown in Fig. 3.12. At chemically correct ratio there is still some oxygen present at the point 3 (in the p - V diagram, refer Fig. 4.1) because of chemical equilibrium effects a rich mixture will cause more fuel to combine with oxygen at that point thereby raising the temperature T_3 . However, at richer mixtures increased formation of CO counters this effect.

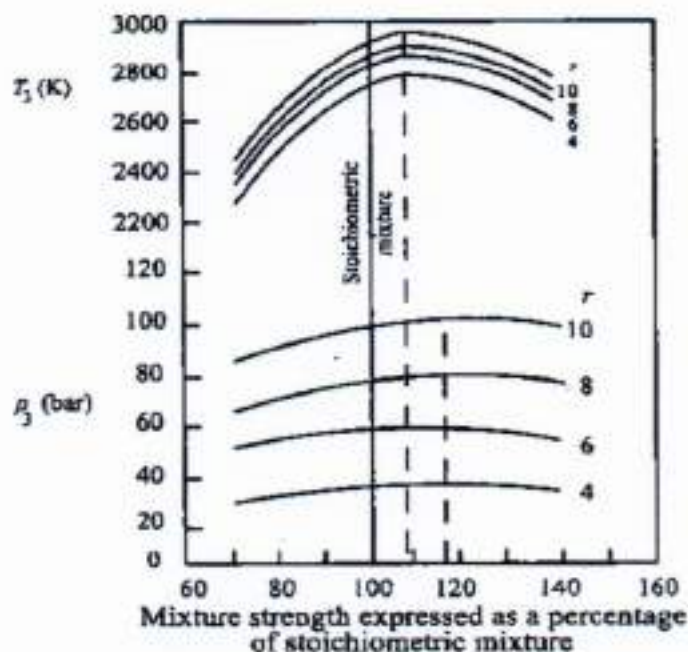

Fig. 3.12 Effect of Equivalence Ratio on T_3 and p_3

- (iv) **Maximum Pressure** : The pressure of a gas in a given space depends upon its temperature and the number of molecules. The curve of p_3 , therefore follows T_3 , but because of the increasing number of molecules p_3 does not start to decrease until the mixture is somewhat richer than that for maximum T_3 (at $F/A = 0.083$ or $A/F = 12 : 1$), i.e. about 20 per cent rich (Fig 3.12).
- (v) **Exhaust Temperature** : The exhaust gas temperature, T_4 is maximum at the chemically correct mixture as shown in Fig 3.13. At this point the fuel and oxygen are completely used up, as the effect of chemical equilibrium is not significant. At lean mixtures, because of less fuel, T_3 is less and hence T_4 is less. At rich mixtures less sensible energy is developed and hence T_4 is less. That is, T_4 varies with fuel-air ratio in the same manner as T_3 except that maximum T_4 is at the chemically correct fuel-air ratio in place of slightly rich fuel-air ratio (6%) as in case of T_3 . However, the behaviour of T_4 with compression ratio is different from that of T_3 as shown in Fig. 4.13. Unlike T_3 , the exhaust gas temperature, T_4 is lower at high compression ratios, because the increased expansion causes the gas to do more work on the piston leaving less heat to be rejected at the end of the stroke. The same effect is present in the case of air-cycle analysis also.

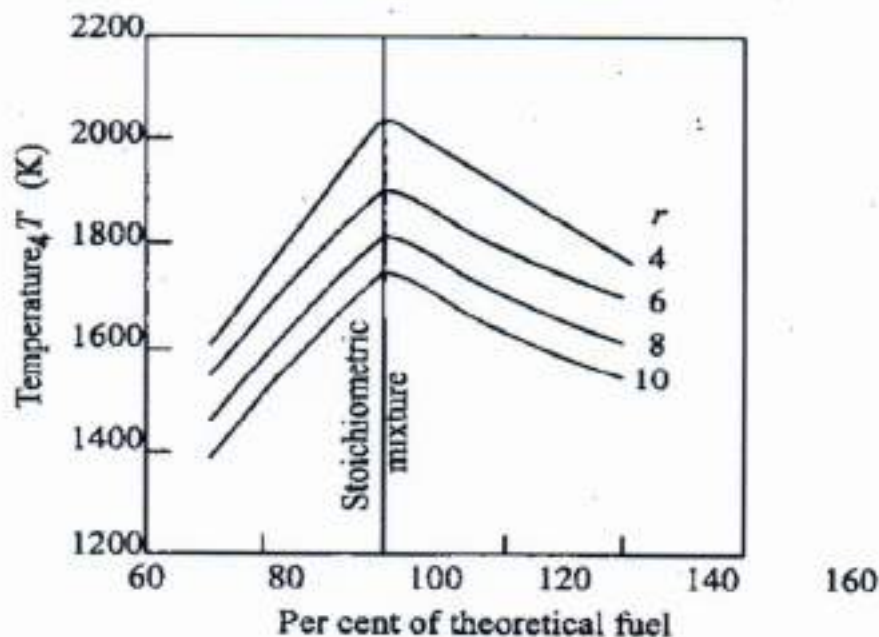

Fig. 3.13 Effect of Fuel-Air Ratio on the Exhaust Gas Temperature

- (vi) **Mean Effective Pressure (mep)** : The mean effective pressure increases with compression ratio. It follows the trend of p_3 and p_4 and hence it is maximum at a fuel-air ratio slightly richer than the chemically correct ratio as shown in Fig 3.14. Table 3.1 shows a summary of conditions which give maximum pressure and temperature in a constant-volume cycle assuming fuel-air cycle approximations.

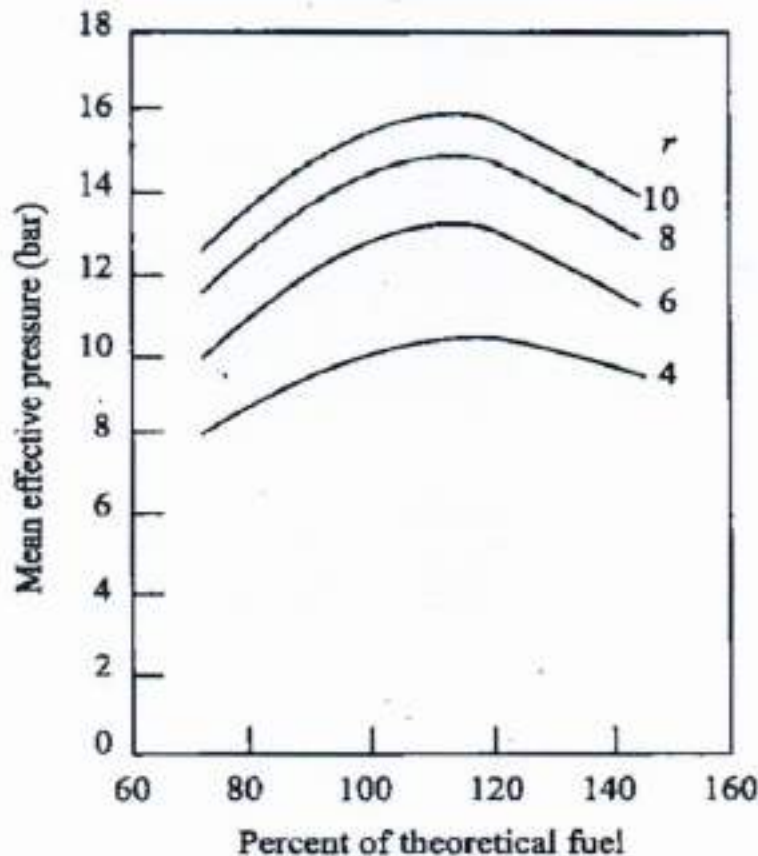

Fig. 3.14 Effect of Fuel-Air Ratio on mep

Table 3.1 Condition for Maximum Temperature and Pressure in a Constant Volume Fuel-Air Cycle

Variable	Maximum at	Reason
1. Temperature, T_3 (Fig.4.12)	6% rich, $F/A = 0.072$; $A/F = 14 : 1, \phi = 1.06$	Because of chemical equilibrium some O_2 still present even at chemically correct F/A ratio. More fuel can be burnt. Limit is reached at 6% rich. If > 6% rich CO formation.
2. Pressure, p_3 (Fig.4.12)	20% rich, $F/A = 0.083$; $A/F = 12 : 1$	$pV = N\bar{R}T$. p depends on T and N
3. Temperature, T_4 (see Fig.4.13)	Chemically correct fuel-air ratio	No effect of chemical equilibrium due to low temperature and incomplete combustion at rich mixture.
4. Mean effective pressure (Fig.4.14)	6% rich, $F/A = 0.0745$; $A/F = 13.5, \phi = 1.05$ to 1.1	mep follows the trend of p_3 and p_4 .

ACTUAL CYCLES AND THEIR ANALYSIS

3.9 INTRODUCTION

The actual cycles for IC engines differ from the fuel-air cycles and air-standard cycles in many respects. The actual cycle efficiency is much lower than the air-standard efficiency due to various losses occurring in the actual engine operation. The major losses are due to:

- (i) Variation of specific heats with temperature
- (ii) Dissociation of the combustion products
- (iii) Progressive combustion
- (iv) Incomplete combustion of fuel
- (v) Heat transfer into the walls of the combustion chamber
- (vi) Blowdown at the end of the exhaust process
- (vii) Gas exchange process

An estimate of these losses can be made from previous experience and some simple tests on the engines and these estimates can be used in evaluating the performance of an engine.

3.10 COMPARISON OF AIR-STANDARD AND ACTUAL CYCLES

The actual cycles for internal combustion engines differ from air-standard cycles in many respects. These differences are mainly due to:

- (i) The working substance being a mixture of air and fuel vapour or finely atomized liquid fuel in air combined with the products of combustion left from the previous cycle.

- (ii) The change in chemical composition of the working substance.
- (iii) The variation of specific heats with temperature.
- (iv) The change in the composition, temperature and actual amount of fresh charge because of the residual gases.
- (v) The progressive combustion rather than the instantaneous combustion.
- (vi) The heat transfer to and from the working medium.
- (vii) The substantial exhaust blowdown loss, i.e., loss of work on the expansion stroke due to early opening of the exhaust valve.
- (viii) Gas leakage, fluid friction etc., in actual engines.

Points (i) to (iv), being related to fuel-air cycles have already been dealt in detail in Chapter 3. Remaining points viz. (v) to (viii) are in fact responsible for the difference between fuel-air cycles and actual cycles.

Most of the factors listed above tend to decrease the thermal efficiency and power output of the actual engines. On the other hand, the analysis of the cycles while taking these factors into account clearly indicates that the estimated thermal efficiencies are not very different from those of the actual cycles.

Out of all the above factors, major influence is exercised by

- (i) *Time loss factor* i.e. loss due to time required for mixing of fuel and air and also for combustion.
- (ii) *Heat loss factor* i.e. loss of heat from gases to cylinder walls.
- (iii) *Exhaust blowdown factor* i.e. loss of work on the expansion stroke due to early opening of the exhaust valve.

These major losses which are not considered in the previous two chapters are discussed in the following sections.

3.1) TIME LOSS FACTOR

In air-standard cycles the heat addition is assumed to be an instantaneous process whereas in an actual cycle it is over a definite period of time. The time required for the combustion is such that under all circumstances some change in volume takes place while it is in progress. The crankshaft will usually turn about 30 to 40° between the initiation of the spark and the end of combustion. There will be a time loss during this period and is called time loss factor.

The consequence of the finite time of combustion is that the peak pressure will not occur when the volume is minimum i.e., when the piston is at *TDC*; but will occur some time after *TDC*. The pressure, therefore,

rises in the first part of the working stroke from b to c as shown in Fig. 3.15. The point 3 represents the state of gases had the combustion been instantaneous and an additional amount of work equal to area shown hatched would have been done. This loss of work reduces the efficiency and is called *time loss due to progressive combustion* or merely *time losses*.

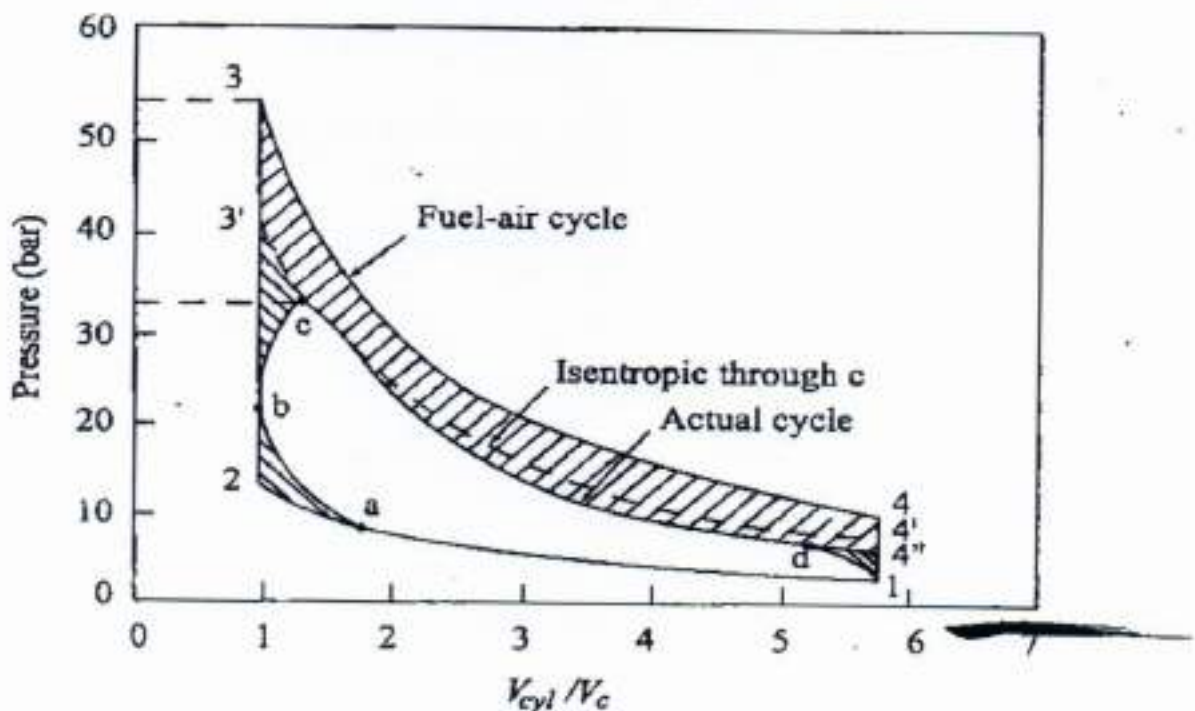

Fig. 3.15 The Effect of Time Losses shown on p - V Diagram

The time taken for the burning depends upon the flame velocity which in turn depends upon the type of fuel and the fuel-air ratio and also on the shape and size of the combustion chamber. Further, the distance from the point of ignition to the opposite side of the combustion space also plays an important role.

In order that the peak pressure is not reached too late in the expansion stroke, the time at which the combustion starts is varied by varying the spark timing or spark advance. Figures 3.16 and 3.17 show the effect of spark timing on p - V diagram from a typical trial. With spark at TDC (Fig. 3.16) the peak pressure is low due to the expansion of gases. If the spark is advanced to achieve complete combustion close to TDC (Fig. 3.17) additional work is required to compress the burning gases.

This represents a direct loss. In either case, viz., with or without spark advance the work area is less and the power output and efficiency are lowered. Therefore, a moderate or optimum spark advance (Fig. 3.18) is the best compromise resulting in minimum losses on both the compression and expansion strokes. Table 3.2 compares the engine performance for various ignition timings. Figure 3.19 shows the effect of spark advance on the power output by means of the p - V diagram. As seen from Fig. 3.20 when the ignition advance is increased there is a drastic reduction in the $imep$ and the

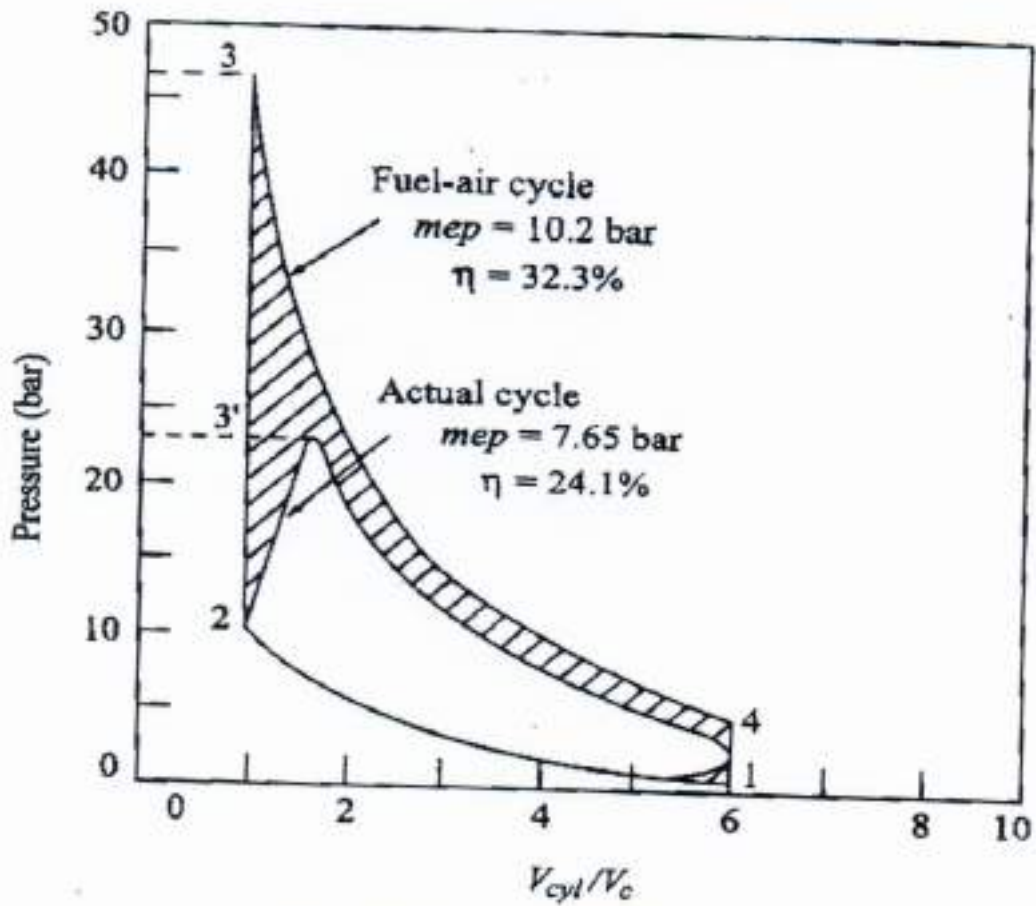

Fig. 3.16 Spark at TDC, Advance 0°

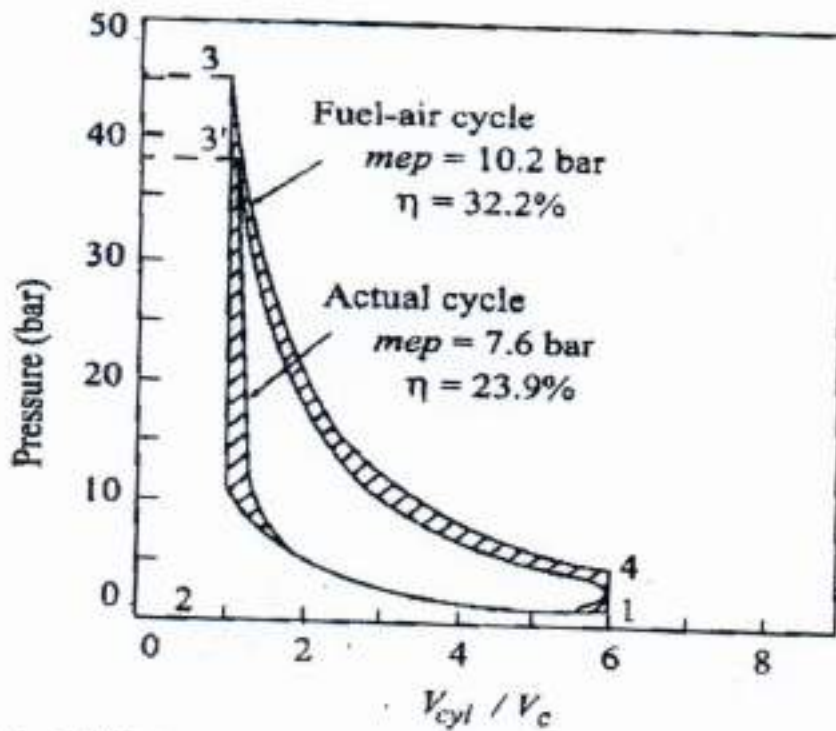

Fig. 3.17 Combustion Completed at TDC, Advance 35°

Table 3.1 Cycle Performance for Various Ignition Timings for $r = 6$
(Typical Values)

Cycle	Ignition advance	Max. cycle pressure bar	mep bar	efficiency %	$\frac{\text{Actual } \eta}{\text{Fuel cycle } \eta}$
Fuel-air cycle	0°	44	10.20	32.2	1.00
Actual cycle	0°	23	7.50	24.1	0.75
"	17°	34	8.35	26.3	0.81
"	35°	41	7.60	23.9	0.74

consequent loss of power. However, some times a deliberate spark retardation from optimum may be necessary in actual practice in order to avoid knocking and to simultaneously reduce exhaust emissions of hydrocarbons and carbon monoxide.

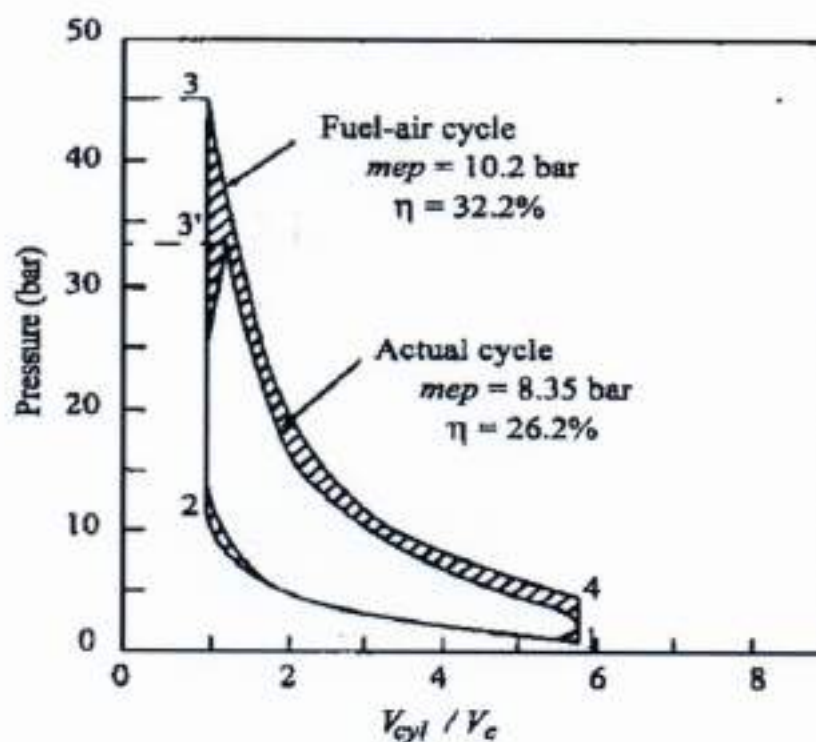

Fig. 3.48 Optimum Advance 15° - 30°

At full throttle with the fuel-air ratio corresponding to maximum power and the optimum ignition advance the time losses may account for a drop in efficiency of about 5 per cent (fuel-air cycle efficiency is reduced by about 2%). These losses are higher when the mixture is richer or leaner when the ignition advance is not optimum and also at part throttle operations the losses are higher. It is impossible to obtain a perfect homogeneous

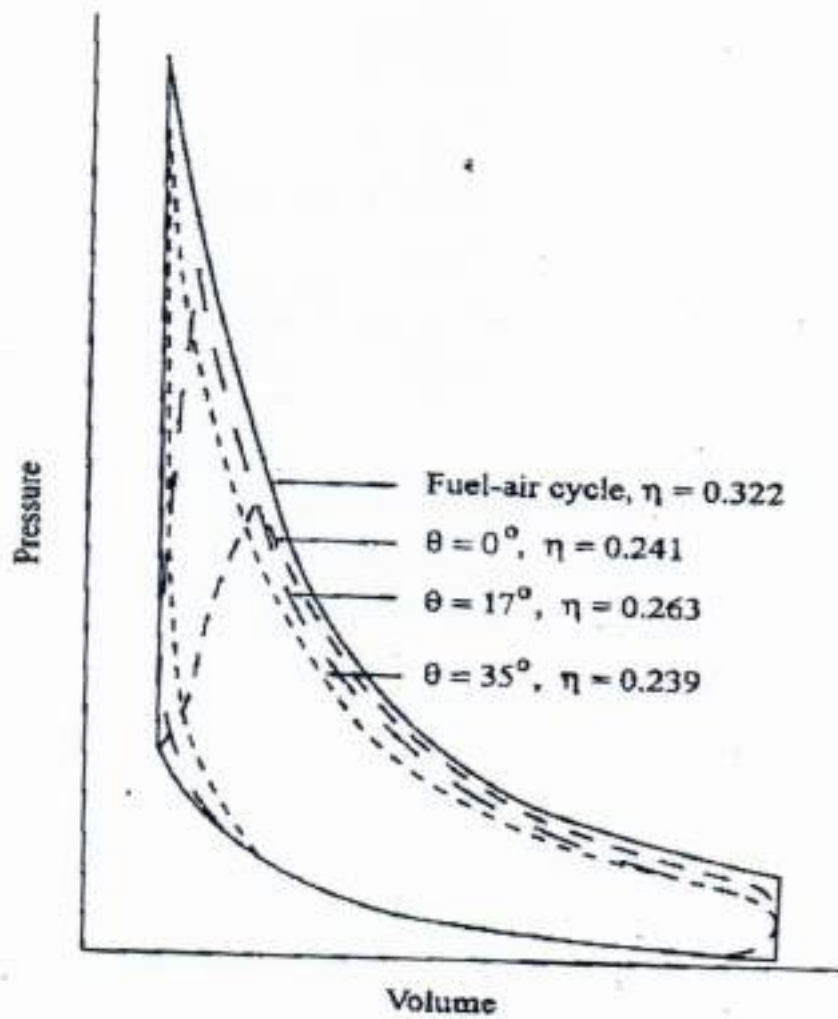

Fig. 3.19 p-V Diagram showing Power Loss due to Ignition Advance

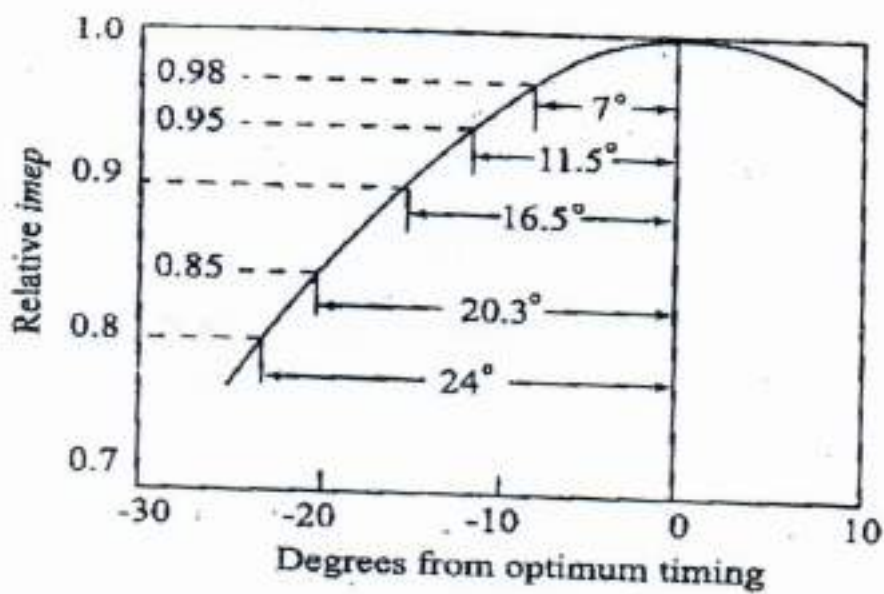

Fig. 3.20 Power Loss due to Ignition Advance

mixture with fuel-vapour and air, since, residual gases from the previous cycle are present in the clearance volume of the cylinder. Further, only very limited time is available between the mixture preparation and ignition. Under these circumstances, it is possible that a pocket of excess oxygen is present in one part of the cylinder and a pocket of excess fuel in another part. Therefore, some fuel does not burn or burns partially to CO and the unused O_2 appears in the exhaust as shown in Fig. 3.2. Energy release data show that only about 95% of the energy is released with stoichiometric fuel-air ratios. Energy release in actual engine is about 90% of fuel energy input.

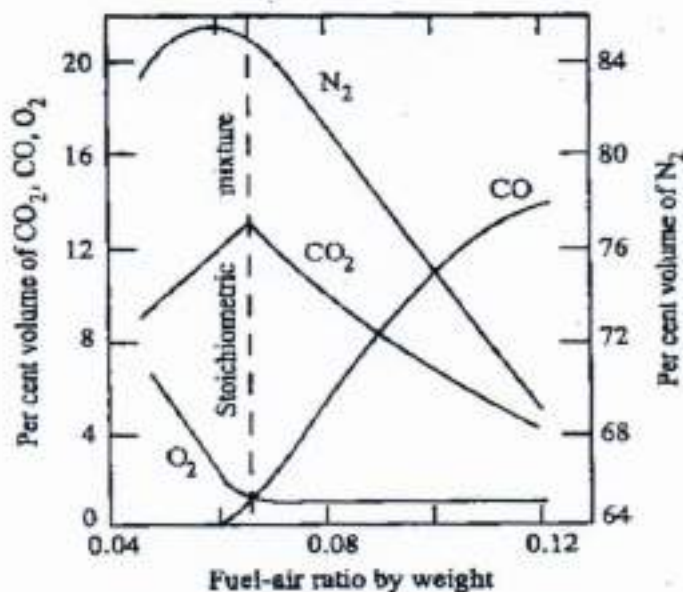

Fig. 3.2] The Composition of Exhaust Gases for Various Fuel-Air Ratios

It should be noted that it is necessary to use a lean mixture to eliminate wastage of fuel, while a rich mixture is required to utilize all the oxygen. Slightly leaner mixture would give maximum efficiency but too lean a mixture will burn slowly increasing the time losses or will not burn at all causing total wastage of fuel. In a rich mixture a part of the fuel will not get the necessary oxygen and will be completely lost. Also the flame speed in mixtures more than 10% richer is low, thereby, increasing the time losses and lowering the efficiency. Even if this unused fuel and oxygen eventually combine during the exhaust stroke and burn, the energy which is released at such a late stage cannot be utilized.

Imperfect mixing of fuel and air may give different fuel-air ratios during suction stroke or certain cylinders in a multicylinder engine may get continuously leaner mixtures than others.

3.42 HEAT LOSS FACTOR

During the combustion process and the subsequent expansion stroke the heat flows from the cylinder gases through the cylinder walls and cylinder

head into the water jacket or cooling fins. Some heat enters the piston head and flows through the piston rings into the cylinder wall or is carried away by the engine lubricating oil which splashes on the underside of the piston. The heat loss along with other losses is shown on the p - V diagram in Fig. 3.82

Heat loss during combustion will naturally have the maximum effect on the cycle efficiency while heat loss just before the end of the expansion stroke can have very little effect because of its contribution to the useful work is very little. The heat lost during the combustion does not represent a complete loss because, even under ideal conditions assumed for air-standard cycle, only a part of this heat could be converted into work (equal to $Q \times \eta_{th}$) and the rest would be rejected during the exhaust stroke. About 15 per cent of the total heat is lost during combustion and expansion. Of this, however, much is lost so late in the cycle to have contributed to useful work. If all the heat loss is recovered only about 20% of it may appear as useful work. Figure 5.8 shows percentage of time loss, heat loss and exhaust loss in a Cooperative Fuel Research (CFR) engine. Losses are given as percentage of fuel-air cycle work. The effect of loss of heat during combustion is to reduce the maximum temperature and therefore, the specific heats are lower. It may be noted from the Fig. 3.82 that of the various losses, heat loss factor contributes around 12%.

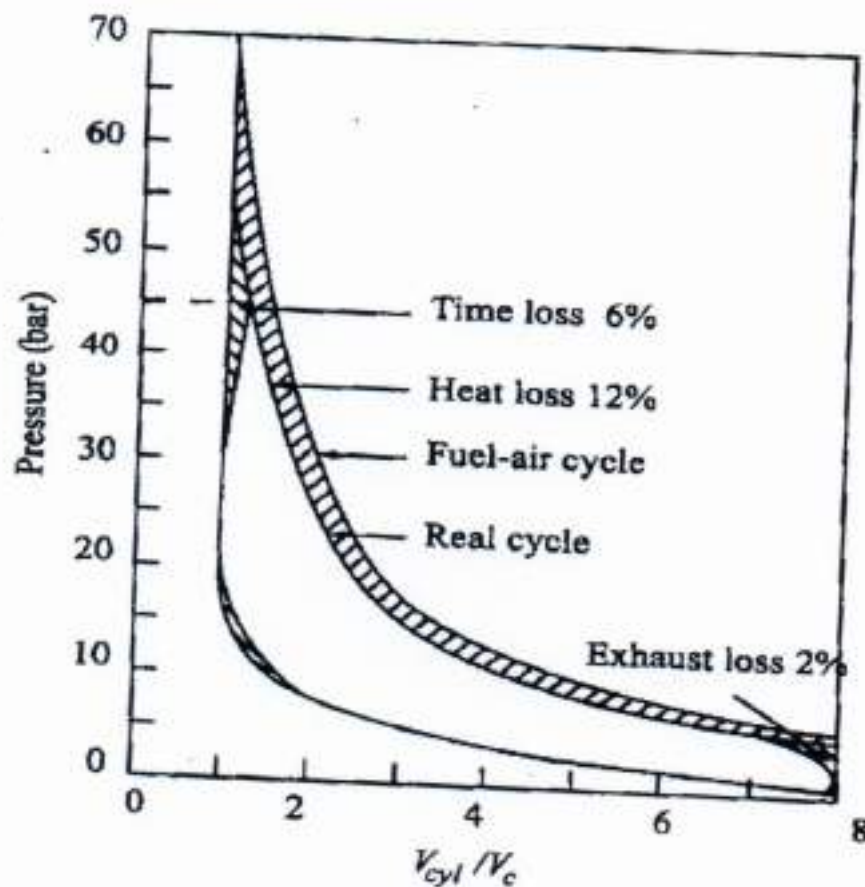

Fig. 3.82) Time Loss, Heat Loss and Exhaust Loss in Petrol Engines

3.13 EXHAUST BLOWDOWN

The cylinder pressure at the end of exhaust stroke is about 7 bar depending on the compression ratio employed. If the exhaust valve is opened at the bottom dead centre, the piston has to do work against high cylinder pressures during the early part of the exhaust stroke. If the exhaust valve is opened too early, a part of the expansion stroke is lost. The best compromise is to open the exhaust valve 40° to 70° before *BDC* thereby reducing the cylinder pressure to halfway (say 3.5 bar) before the exhaust stroke begins. This is shown in Fig. 3.93 by the roundness at the end of the diagram.

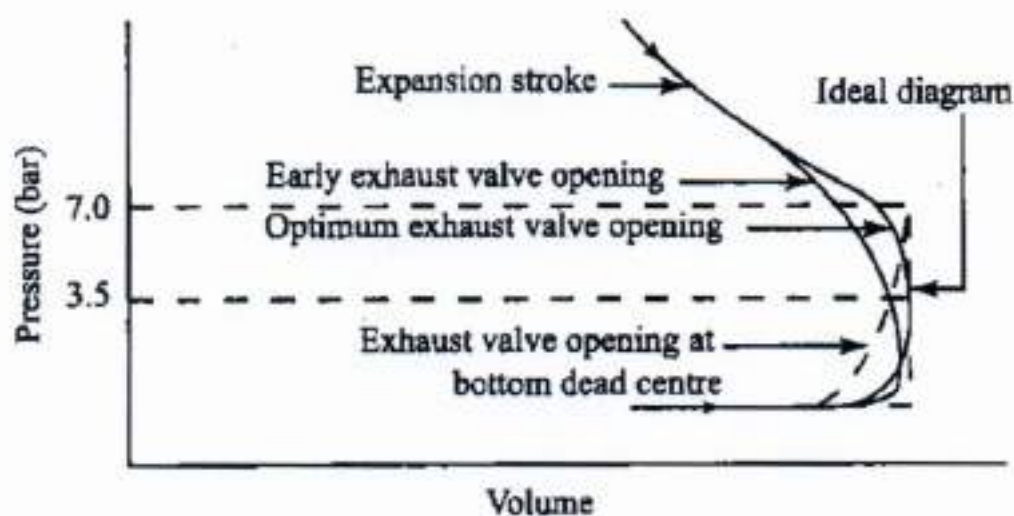

Fig. 3.93 Effect of Exhaust Valve Opening Time on Blowdown

Worked out Examples

3.1 What will be the effect on the efficiency of an Otto cycle having a compression ratio of 8, if C_v increases by 1.6%?

Solution

$$\begin{aligned}\eta_{\text{Otto}} &= 1 - \frac{1}{r^{\gamma-1}} \\ C_p - C_v &= R \\ \frac{C_p}{C_v} &= \gamma \\ \gamma - 1 &= \frac{R}{C_v} \\ \eta &= 1 - \left(\frac{1}{r}\right)^{R/C_v} \\ 1 - \eta &= r^{-R/C_v} \\ \ln(1 - \eta) &= \frac{-R}{C_v} \ln r\end{aligned}$$

Differentiating

$$\begin{aligned}-\frac{1}{1 - \eta} d\eta &= \frac{R}{C_v^2} \ln r dC_v \\ d\eta &= -\frac{(1 - \eta)R \ln r}{C_v^2} dC_v \\ \frac{d\eta}{\eta} &= -\frac{(1 - \eta)(\gamma - 1) \ln r}{\eta} \frac{dC_v}{C_v}\end{aligned}$$

Now,

$$\begin{aligned}\eta &= 1 - \left(\frac{1}{8}\right)^{0.4} = 0.565 = 56.5\% \\ \frac{d\eta}{\eta} &= -\frac{(1 - 0.565) \times (1.4 - 1) \times \ln 8}{0.565} \times \frac{1.6}{100} \\ &= -1.025\% \quad \text{Ans}\end{aligned}$$

3.2 What will be the effect on the efficiency of a diesel cycle having a compression ratio of 20 and a cut-off ratio is 5% of the swept volume, if the C_v increases by 1%. Take $C_v = 0.717$ and $R = 0.287$ kJ/kg K.

Solution

$$\eta_{\text{Diesel}} = 1 - \left(\frac{1}{r}\right)^{\gamma-1} \left(\frac{1}{\gamma} \frac{r_c^\gamma - 1}{r_c - 1}\right)$$

$$1 - \eta = \frac{1}{\gamma} \frac{r_c^\gamma - 1}{r^{\gamma-1}(r_c - 1)}$$

Taking logarithm

$$\ln(1 - \eta) = -\ln \gamma + \ln(r_c^\gamma - 1) - \ln(r_c - 1) - (\gamma - 1) \ln r$$

$$\gamma - 1 = \frac{R}{C_v}$$

$$\gamma = \left(1 + \frac{R}{C_v}\right)$$

Substituting this in the above equation

$$\begin{aligned} \ln(1 - \eta) = & -\ln\left(\frac{R}{C_v} + 1\right) + \ln\left(r_c^{\left(\frac{R}{C_v} + 1\right)} - 1\right) \\ & - \ln(r_c - 1) - \frac{R}{C_v} \ln r \end{aligned}$$

Differentiating we get,

$$\frac{d\eta}{\eta} = \frac{\frac{R}{C_v} dC_v}{\frac{R}{C_v} + 1} - \frac{\frac{R}{C_v} \left(r_c^{\left(\frac{R}{C_v} + 1\right)} \ln r_c dC_v\right)}{r_c^{\left(\frac{R}{C_v} + 1\right)} - 1} + \frac{R}{C_v} \ln r dC_v$$

$$\frac{d\eta}{\eta} = -\frac{dC_v}{C_v} \frac{R}{C_v} \left(\frac{1 - \eta}{\eta}\right)$$

$$\times \left(\frac{1}{\frac{R}{C_v} + 1} + \ln r - \frac{r_c^{\frac{R}{C_v} + 1} \ln(r_c)}{r_c^{\frac{R}{C_v} + 1} - 1} \right)$$

$$\frac{d\eta}{\eta} = -\frac{dC_v}{C_v} \left(\frac{1 - \eta}{\eta}\right) (\gamma - 1) \left[\frac{1}{\gamma} + \ln r - \frac{r_c^\gamma \ln(r_c)}{r_c^\gamma - 1} \right]$$

$$\gamma = 1.4$$

$$\frac{V_1}{V_2} = r = 20$$

$$V_1 = 20V_2$$

$$V_s = 20V_2 - V_2 = 19V_2$$

$$V_3 = 0.05V_s + V_2 = (0.05 \times 19V_2) + V_2 = 1.95V_2$$

$$r_c = \frac{V_3}{V_2} = \frac{1.95V_2}{V_2} = 1.95$$

$$\gamma = 1.4$$

$$\eta = 1 - \frac{1}{\gamma} \frac{1}{r_c^{\gamma-1}} \frac{r_c^\gamma - 1}{r_c - 1}$$

$$= 1 - \frac{1}{1.4} \times \left(\frac{1}{20}\right)^{0.4} \times \frac{1.95^{1.4} - 1}{1.95 - 1} = 0.649$$

$$\frac{d\eta}{\eta} = -0.01 \times \frac{1 - 0.649}{0.649}$$

$$\times 0.4 \times \left[\frac{1}{1.4} + \ln(20) - \frac{1.95^{1.4} \times \ln(1.95)}{1.95^{1.4} - 1} \right]$$

$$= -0.565\%$$

Ans

- 3.3 A petrol engine having a compression ratio of 6 uses a fuel with calorific value of 42 MJ/kg. The air-fuel ratio is 15:1. Pressure and temperature at the start of the suction stroke is 1 bar and 57 °C respectively. Determine the maximum pressure in the cylinder if the index of compression is 1.3 and the specific heat at constant volume is given by $C_v = 0.678 + 0.00013 T$, where T is in Kelvin. Compare this value with that obtained when $C_v = 0.717$ kJ/kg K.

Solution Consider the process 1-2

$$p_2 V_2^n = p_1 V_1^n$$

$$p_2 = p_1 \left(\frac{V_1}{V_2}\right)^n = 1 \times 6^{1.3} = 10.27 \text{ bar}$$

$$T_2 = T_1 \left(\frac{p_2 V_2}{p_1 V_1}\right)$$

$$= 330 \times \left(\frac{10.27}{1} \times \frac{1}{6}\right) = 565 \text{ K}$$

Average temperature during combustion

$$= \frac{T_3 + T_2}{2}$$

$$C_{v_{\text{mean}}} = 0.678 + 0.00013 \times \left(\frac{T_3 + T_2}{2}\right)$$

Assuming unit quantity of air

$$Q_{2-3}/\text{kg of air} = \frac{42}{15} = 2.8 \text{ MJ}$$

$$\text{Mass of charge} = 1 + \frac{1}{15} = \frac{16}{15} \text{ kg/kg of air}$$

$$Q_{2-3} = C_{v, \text{mean}} \dot{m} (T_3 - T_2)$$

$$2.8 \times 10^3 = \left[0.678 + 13 \times 10^{-5} \times \left(\frac{T_3 + 565}{2} \right) \right] \\ \times \frac{16}{15} \times (T_3 - 565)$$

Solving for T_3 we get

$$T_3 = 3375 \text{ K}$$

$$p_3 = p_2 \frac{T_3}{T_2} = 10.27 \times \frac{3375}{565}$$

$$= 61.35 \text{ bar}$$

Ans

For constant specific heat

$$2.8 \times 10^3 = 0.717 \times \frac{16}{15} \times (T_3 - 565)$$

On solving

$$T_3 = 4226$$

$$p_3 = 10.27 \times \frac{4226}{565} = 76.81 \text{ bar}$$

Ans

- 3.4 An oil engine, working on the dual combustion cycle, has a compression ratio of 13:1. The heat supplied per kg of air is 2000 kJ, half of which is supplied at constant volume and the other half at constant pressure. If the temperature and pressure at the beginning of compression are 100 °C and 1 bar respectively, find (i) the maximum pressure in the cycle and (ii) the percentage of stroke when cut-off occurs. Assume $\gamma = 1.4$, $R = 0.287 \text{ kJ/kg K}$ and $C_v = 0.709 + 0.000028T \text{ kJ/kg K}$.

Solution

$$p_1 V_1^\gamma = p_2 V_2^\gamma$$

$$p_2 = p_1 \left(\frac{V_1}{V_2} \right)^\gamma = 1 \times 10^5 \times 13^{1.4}$$

$$= 36.27 \times 10^5 \text{ N/m}^2$$

$$T_1 V_1^{(\gamma-1)} = T_2 V_2^{\gamma-1}$$

For unit mass :

Consider the process 2-3,

$$Q_{2-3} = \frac{1}{2} \times 2000 = 1000 \text{ kJ}$$

$$Q_{2-3} = m \int_2^3 (0.709 + 0.000028T) dT$$

$$1000 = 0.709 \times (T_3 - 1040.6) + \frac{0.000028}{2} \times (T_3^2 - 1040.6^2)$$

$$T_3 = 2362.2 \text{ K}$$

$$p_3 = p_2 \left(\frac{T_3}{T_2} \right) = 36.27 \times \left(\frac{2362.2}{1040.6} \right) \times 10^5$$

$$= 82.34 \times 10^5 \text{ N/m}^2 \quad \underline{\underline{\text{Ans}}}$$

Consider the process 3-4,

$$Q_{3-4} = \frac{1}{2} \times 1000 = 500 \text{ kJ}$$

$$C_p = C_v + R = 0.996 + 0.000028 T$$

$$Q_{3-4} = m \int_3^4 dT$$

$$500 = \int_3^4 (0.996 + 0.000028) dT$$
$$= 0.996 \times (T_4 - 2362.2) + \frac{0.000028}{2} \times (T_4^2 - 2362.2^2)$$

$$T_4 = 2830.04 \text{ K}$$

$$V_4 = V_3 \left(\frac{T_4}{T_3} \right) = \frac{2830.04}{2362.2} V_3 = 1.198 V_3$$

$$V_s = V_4 - V_3 = V_3(r - 1) = 12 V_3$$

$$\text{Cut-off \% of stroke} = \frac{V_4 - V_3}{V_s} \times 100 = \frac{V_4 - V_3}{12 V_3} \times 100$$

$$= \frac{1.198 - 1}{12} \times 100 = 1.65\% \quad \underline{\underline{\text{Ans}}}$$

CHAPTER FOUR

Combustion Processes

4.1 Analysis of Combustion Products:

'Fuel' refers to a combustible substance capable of releasing heat during its combustion. In general fuels have carbon, hydrogen and sulphur as the major combustible chemical elements. Sulphur is found to be relatively less contributor to the total heat released during combustion. Fuels may be classified as solid, liquid and gaseous fuel depending upon their state.

Solid fuel: Coal is the most common solid fuel. Coal is a dark brown/black sedimentary rock derived primarily from the unoxidized remains of carbon-bearing plant tissues. It can be further classified into different types based upon the composition. Composition can be estimated using either "proximate analysis" or by "ultimate analysis". Proximate analysis is the one in which the individual constituent element such as C, H₂, S, N₂ etc. are not determined rather only fraction of moisture, volatile matter, ash, carbon etc. are determined.

Liquid fuels: Fuels in liquid form are called liquid fuels. Liquid fuels are generally obtained from petroleum and its by-products. These liquid fuels are complex mixture of different hydrocarbons, and obtained by refining the crude petroleum oil. Commonly used liquid fuels are petrol, kerosene diesel, aviation fuel, light fuel oil, heavy fuel oil etc.

Gaseous fuels: These are the fuels in gaseous phase. Gaseous fuels are also generally hydrocarbon fuels derived from petroleum reserves available in nature. Most common gaseous fuel is natural gas. Gaseous fuels may also be produced artificially from burning solid fuel (coal) and water. Some of gaseous fuels produced artificially are coal gas, producer gas etc.

For combustion calculations the air is considered to be comprising of nitrogen and oxygen in following proportions. Molecular weight of air is taken as 29.

Composition of air by mass = Oxygen (23.3%) + Nitrogen (76.7%)

Composition of air by volume = Oxygen (21%) + Nitrogen (79%)

Wet and dry analysis of combustion: Combustion analysis when carried out considering water vapour into account is called "wet analysis" while the analysis made on the assumption that vapour is removed after condensing it, is called "dry analysis".

Volumetric and gravimetric analysis: Combustion analysis when carried out based upon percentage by volume of constituent reactants and products is called volumetric analysis.

Combustion analysis carried out based upon percentage by mass of reactants and products is called gravimetric analysis.

4.2 Combustion Equations:

Proportionate masses of air and fuel enter the combustion chamber where the chemical reaction takes place, and from which the products of combustion pass to the exhaust. By the conservation of mass the mass flow remains constant (i.e. total mass of products equals total mass of reactants), but the reactants are chemically different from the products, and the products leave at a higher temperature. The total number of atoms of each element concerned in the combustion remains constant, but the atoms are rearranged into groups having different chemical properties. This information is expressed in the chemical equation which shows:

- (i) the reactants and the products of combustion;
- (ii) the relative quantities of the reactants and products.

The two sides of the equation must be consistent, each having the same number of atoms of each element involved. It should not be assumed that if an equation can be written, that the reaction it represents is inevitable or even possible. For possibility and direction the reaction has to be considered with reference to the Second Law of Thermodynamics. For the present the only concern is known combustion equations.

The equation shows the number of molecules of each reactant and product. The amount of substance, introduced in section 2.3, is proportional to the number of molecules, hence the relative numbers of molecules of the reactants and the products give the molar, and therefore the volumetric, analysis of the gaseous constituents.

As stated earlier the oxygen supplied for combustion is usually provided by atmospheric air, and it is necessary to use accurate and consistent analyses of air by mass and by volume. It is usual in combustion calculations to take air as 23.3% O₂, 76.7% N₂ by mass, and 21% O₂, 79% N₂ by volume. The small traces of other gases in dry air are included in the nitrogen, which is sometimes called 'atmospheric nitrogen'.

Consider the combustion equation for hydrogen:

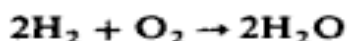

(4.1)

This tells us that

- (i) hydrogen reacts with oxygen to form steam or water;
- (ii) two molecules of hydrogen react with one molecule of oxygen to give two molecules of steam or water,

i.e. 2 volumes H₂ + 1 volume O₂ → 2 volumes H₂O

The H₂O may be a liquid or a vapour depending on whether the product has been cooled sufficiently to cause condensation. The proportions by mass are obtained by using relative atomic masses,

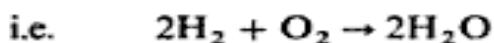

therefore

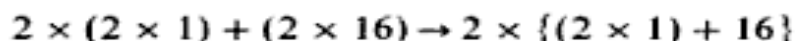

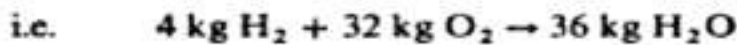

The same proportions are obtained by writing equation (7.1) as $\text{H}_2 + \frac{1}{2}\text{O}_2 \rightarrow \text{H}_2\text{O}$, and this is sometimes done.

It will be noted from equation (7.1) that the total volume of the reactants is 2 volumes $\text{H}_2 + 1$ volume $\text{O}_2 = 3$ volumes. The total volume of the product is only 2 volumes. There is therefore a volumetric contraction on combustion.

Since oxygen is accompanied by nitrogen if air is supplied for the combustion, then this nitrogen should be included in the equation. As nitrogen is inert as far as the chemical reaction is concerned, it will appear on both sides of the equation.

With 1 kmol of oxygen there are $79/21$ kmol of nitrogen, hence equation (4.1) becomes

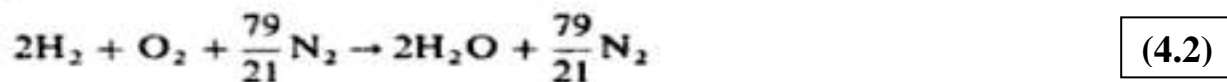

Similar equations can be found for the combustion of carbon. There are two possibilities to consider:

(i) The complete combustion of carbon to carbon dioxide



and including the nitrogen



Considering the volumes of reactants and products

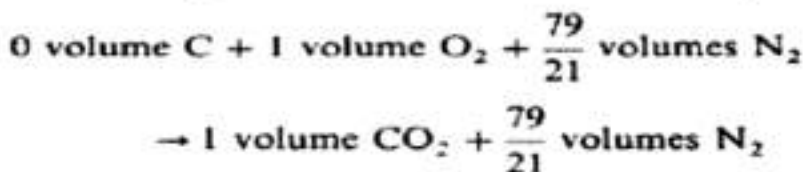

The volume of carbon is written as zero since the volume of a solid is negligible in comparison with that of a gas.

By mass

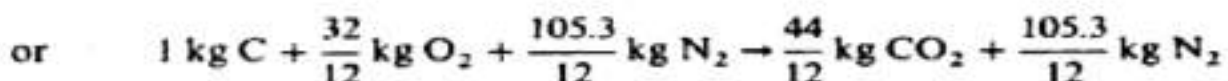
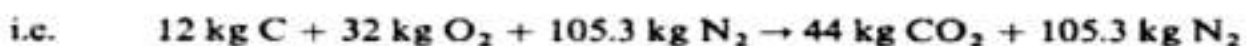
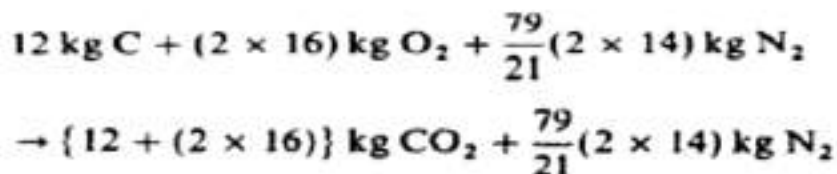

(ii) The incomplete combustion of carbon. This occurs when there is an insufficient supply of oxygen to burn the carbon completely to carbon dioxide,

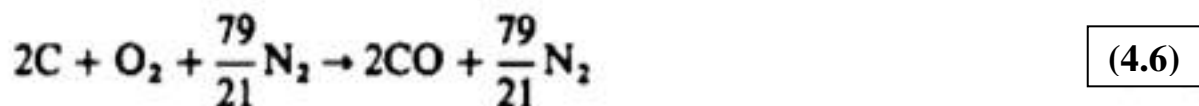

By mass

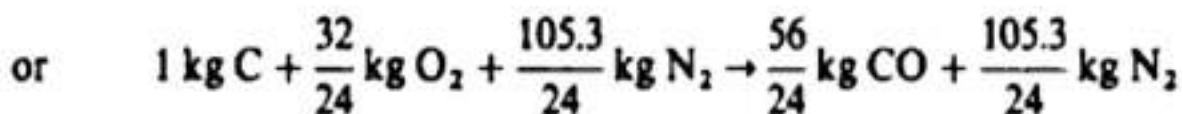
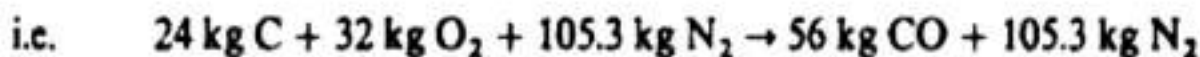
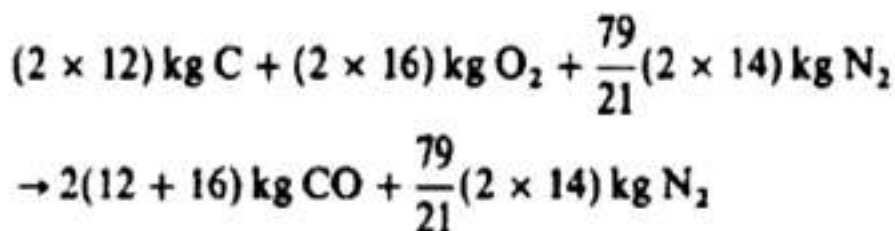

If a further supply of oxygen is available then the combustion can continue to completion

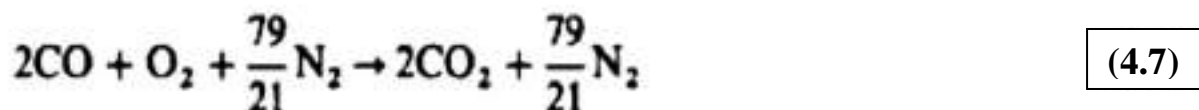

By mass,

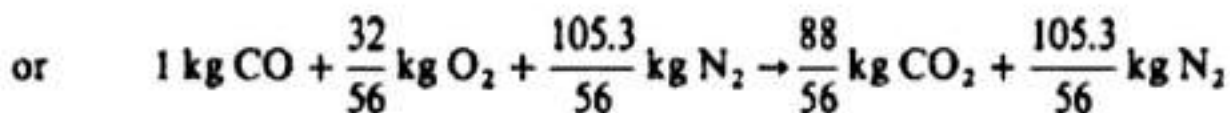

4.3 Stoichiometric Air - Fuel Ratio (A/F):

A stoichiometric mixture of air and fuel is one that contains just sufficient oxygen for the complete combustion of the fuel. A mixture which has an excess of air is termed a *weak mixture*, and one which has a deficiency of air is termed a *rich mixture*. The percentage of excess air is given by the following:

Percentage excess air

$$= \frac{\text{actual A/F ratio} - \text{stoichiometric A/F ratio}}{\text{stoichiometric A/F ratio}}$$

(4.8)

where A denotes air and F denotes fuel.

For gaseous fuels the ratios are expressed by volume and for solid and liquid fuels the ratios are expressed by mass. Equation (7.8) gives a positive result when the mixture is weak, and a negative result when the mixture is rich. For boiler plant the mixture is usually greater than 20% weak; for gas turbines it can be as much as 300% weak. Petrol engines have to meet various conditions of load and speed, and operate over a wide range of mixture strengths. The

following definition is used:

$$\text{Mixture strength} = \frac{\text{stoichiometric A/F ratio}}{\text{actual A/F ratio}}$$

(4.9)

The working values range between 80% (weak) and 120% (rich) (see section 13.6).

Where fuels contain some oxygen (e.g. ethyl alcohol C_2H_6O) this oxygen is available for the combustion process, and so the fuel requires a smaller supply of air.

The atoms of different elements have different masses and these values are important when a quantitative analysis is required. The actual masses are infinitesimally small, and the ratios of the masses of atoms are used. These ratios are given by the relative atomic masses quoted on a scale which defines the atomic mass of isotope 12 of carbon as 12 (see Ch. 2, p. 40). The *relative atomic mass* of a substance is the mass of a single entity of the substance relative to a single entity of carbon-12. Table 7.1 gives the relative atomic masses of some common elements rounded off to give values accurate enough for most purposes.

Element	Oxygen	Hydrogen	Carbon	Sulphur	Nitrogen
Atomic symbol	O	H	C	S	N
Relative atomic mass	16	1	12	32	14
Molecular grouping	O ₂	H ₂	C	S	N ₂
Relative molecular mass (rounded)	32	2	12	32	28
Accurate values	31.999	2.016	12	32.030	28.013

4.4 Analysis of Experimental Combustion Products:

Flue gas analysis refers to the determination of composition of exhaust gases. Flue gas analysis can be done theoretically and experimentally. Here experimental method of flue gas analysis is described. Various devices available for measuring the composition of products of combustion (flue gas) are Orsat Analyzer, Gas chromatograph, Infrared analyzer and Flame ionisation detector etc. Data from these devices can be used to determine the mole fraction of flue gases. Generally this analysis is done on dry basis which may also be termed as “dry product analysis” and it refers to describing mole fractions for all gaseous products except water vapour.

Orsat analyzer: It is also called as Orsat apparatus and is used for carrying out volumetric analysis of dry products of combustion. Schematic of apparatus is shown in Fig.10.3 It has three flasks containing different chemicals for absorption of CO_2 , O_2 and CO respectively and a graduated eudiometer tube connected to an aspirator bottle filled with water.

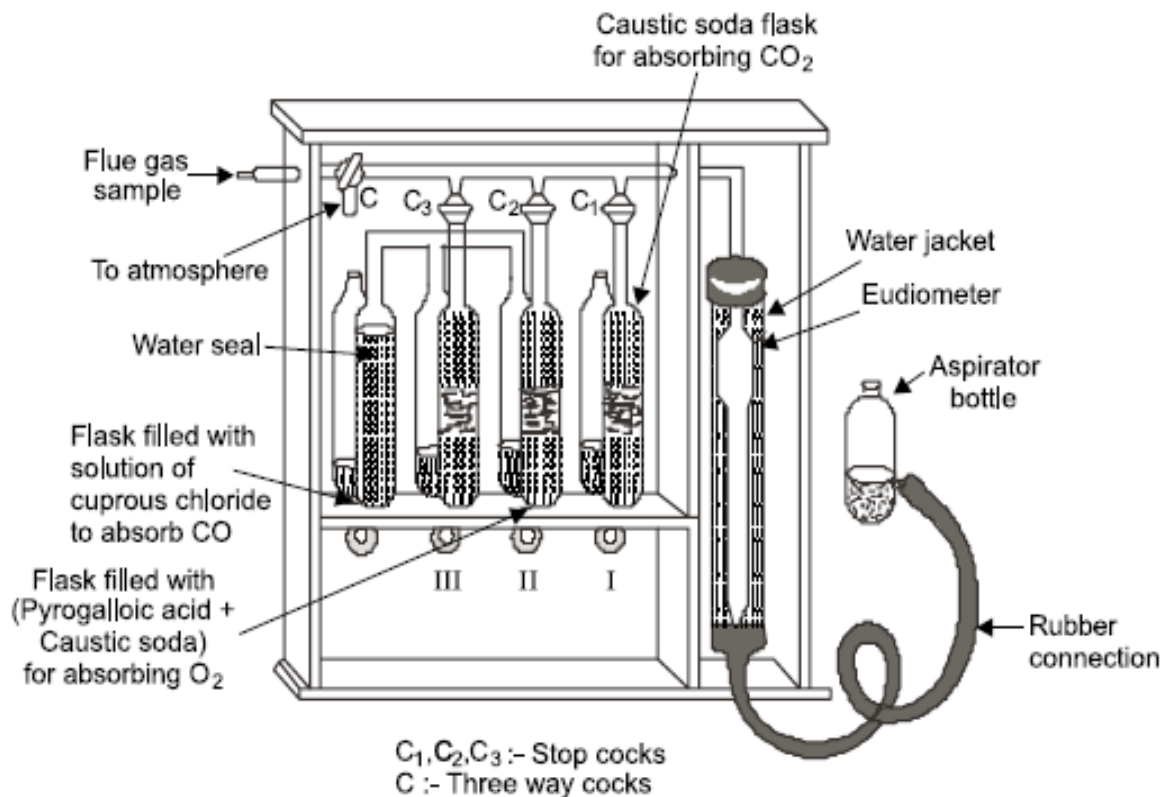

Fig. 4.1 : Orsat analyzer

Flask I is filled with NaOH or KOH solution (about one part of KOH and 2 parts of water by mass). This 33% KOH solution shall be capable of absorbing about fifteen to twenty times its own volume of CO₂. Flask II is filled with alkaline solution of pyrogallic acid and above KOH solution. Here 5 gm of pyrogallic acid powder is dissolved in 100 cc of KOH solution as in Flask I. It is capable of absorbing twice its own volume of O₂. Flask III is filled with a solution of cuprous chloride which can absorb CO equal to its' volume. Cuprous chloride solution is obtained by mixing 5 mg of copper oxide in 100 cc of commercial HCl till it becomes colorless. Each flask has a valve over it and C₁, C₂, C₃ valves are put over flasks I, II and III. All the air or any other residual gas is removed from eudiometer by lifting the aspirator bottle and opening main valve. The flue gas for analysis is taken by opening the main valve (three way valve) while valves C₁, C₂ and C₃ are closed. 100 cc of flue gas may be taken into eudiometer tube by lowering aspirator bottle until the level is zero and subsequently forced into flasks for absorbing different constituents. Aspirator bottle is lifted so as to inject flue gas into flask I with only valve C₁ in open state where CO₂ present shall be absorbed. Aspirator bottle is again lowered and reading of eudiometer tube taken. Difference in readings of eudiometer tube initially and after CO₂ absorption shall give percentage of CO₂ by volume. Similar steps may be repeated for getting O₂ and CO percentage by volume for which respective flask valve shall be opened and gas passed into flask.

Thus Orsat analyzer directly gives percentage by volume of constituents. In case of other constituents to be estimated the additional flasks with suitable chemical may be used. The remaining volume in eudiometer after absorption of all constituents except N₂ shall give percentage volume of N₂ in flue gas. As in combustion of hydrocarbon fuel the H₂O is present in flue gases but in orsat analysis dry flue gases are taken which means H₂O will be condensed and separated out. Therefore the percentage by volume of constituents estimated shall be on higher side as in actual product H₂O is there but in dry flue gas it is absent. Orsat analyzer does not give exact analysis.

4.5 Internal Energy and Enthalpy of Reaction:

Previous consideration of the combustion process has not included the energy released during the process and final temperatures attained. It is evident, however, that such a process must obey the First Law of Thermodynamics. Applications of this law to other processes have been for pure substances, or those that can be considered to be so, with the stipulation that their thermodynamic state is defined by two independent properties. In the type of process now considered there is the potential chemical energy of the fuel to be included which is released during the change from reactants to products.

It is an experimental fact that the energy released on the complete combustion of unit mass of a fuel depends on the temperature at which the process is carried out. Thus such quantities quoted are related to temperature. It will be shown that if the energy release is known for a fuel at one temperature it can be calculated at other temperatures.

The combustion process is defined as taking place from reactants at a state identified by the reference temperature T_0 and another property, either pressure or volume, to products at the same state. If the process is carried out at constant volume then the non-flow energy equation, $Q + W = (U_2 - U_1)$, can be applied to give

$$Q = U_{P_0} - U_{R_0} \quad \text{or} \quad -Q = U_{R_0} - U_{P_0} \quad (4.10)$$

where $W = 0$ for constant volume combustion, $U_1 = U_{R_0}$ the internal energy of the reactants which is a mixture of fuel and air at T_0 , and $U_2 = U_{P_0}$ the internal energy of the products of combustion at T_0 .

The change in internal energy does not depend on the path between the two states but only on the initial and final values and is given by the quantity, $-Q$, the heat transferred to the surroundings during the process. This is illustrated in Fig. 7.8 and also the property diagram of Fig. 7.9.

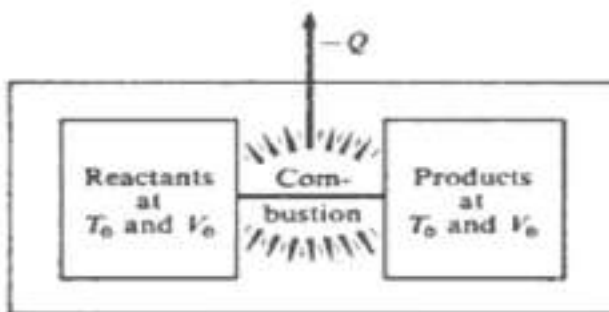

The heat supplied, Q , is called the *internal energy of reaction at T_0* and is denoted by ΔU_0 .

$$\text{i.e.} \quad Q = \Delta U_0 = U_{P_0} - U_{R_0} \quad (4.11)$$

The molar internal energy of reaction at a standard pressure of 1 bar is defined as $\Delta \bar{u}^0 = \Delta U_0/n$, where n is the amount of substance of the fuel.

As the internal energy of the reactants includes the potential chemical energy,

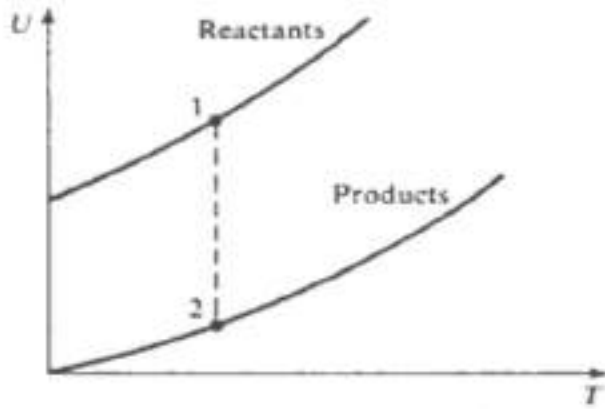

and since heat is transferred *from* the system, it is evident that as defined ΔU_0 is a negative quantity.

For real constant volume combustion processes the initial and final temperatures will be different from the reference temperature T_0 . For analytical purposes the change in internal energy between reactants at state 1 to products at state 2 can be considered in three stages:

- (a) the change for the reactants from state 1 to the reference temperature T_0 ;
- (b) the constant volume combustion process from reactants to products at T_0 ;
- (c) the change for the products from T_0 to state 2.

The complete process can be conceived as taking place in a piston-cylinder device as indicated in Fig. 7.10.

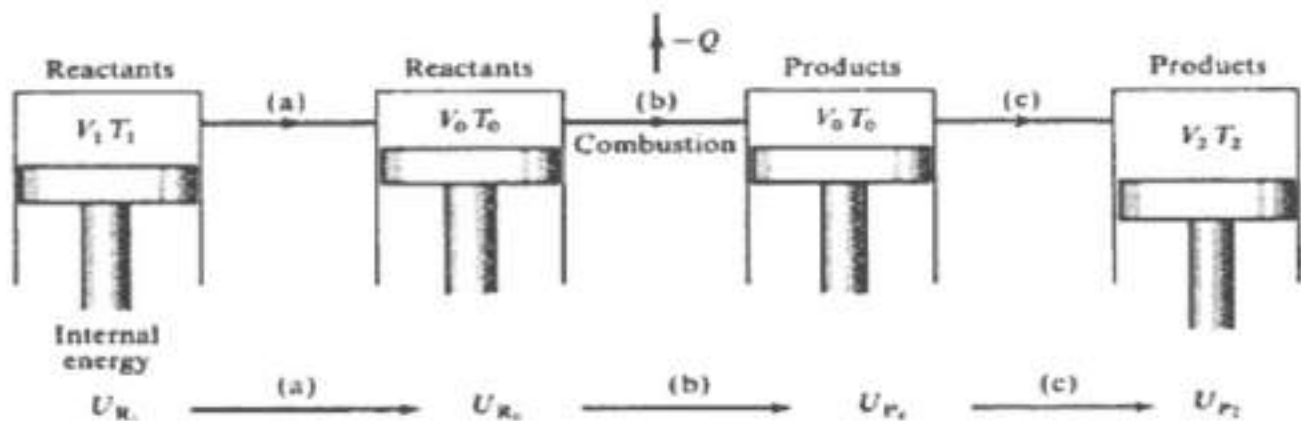

Thus the change in internal energy between states 1 and 2, $(U_2 - U_1)$, can be written more explicitly as, $(U_{P_2} - U_{R_1})$, to show the chemical change involved and this can be further expanded for analytical purposes:

$$U_{P_2} - U_{R_1} = (U_{P_2} - U_{P_0}) + (U_{P_0} - U_{R_0}) + (U_{R_0} - U_{R_1})$$

therefore

$$U_{P_2} - U_{R_1} = \underbrace{(U_{P_2} - U_{P_0})}_{\text{Products (c)}} + \underbrace{\Delta U_0}_{\text{(b)}} + \underbrace{(U_{R_0} - U_{R_1})}_{\text{Reactants (a)}}$$

(4.12)

The non-flow energy equation applied to a process involving combustion and work gives

$$Q + W = U_{P_2} - U_{R_1}$$

It can be seen that the expression for $U_{P_2} - U_{R_1}$ has been conveniently split up to give a term $U_{P_2} - U_{P_1}$ which requires the product mixture to be regarded as a single substance or a summation of single substance constituents, a similar term for the reactants and the quantity ΔU_0 previously defined. The values of internal energy for the constituents of the mixtures remain to be determined. These are functions of temperature and the most accurate method is to use tabulated values such as those of ref. 7.6. In some cases it is a good approximation to calculate changes in internal energy assuming the gaseous constituents to be perfect using an average value of c_v for the temperature range involved. If the temperature range is T_1 to T_2 then the value of c_v at $T = (T_1 + T_2)/2$ can be used, this assumes a linear change in c_v with temperature, but if the temperature range is large the result may not be accurate enough and tabulated values of the properties are required. The tables of ref. 7.6 give the values of \bar{u} and \bar{h} with $\bar{h} = 0$ at the normal reference temperature of $25^\circ\text{C} = 298.15\text{ K}$; \bar{u} and \bar{h} are virtually independent of pressure.

The changes in internal energy for the reactants ($U_{R_0} - U_{R_1}$) and for the products ($U_{P_2} - U_{P_1}$) can be calculated from the following expressions:

$$U_{R_0} - U_{R_1} = \sum_{\mathbf{R}} n_i (\bar{u}_{i_0} - \bar{u}_{i_1}) \quad (4.13)$$

where $\Sigma_{\mathbf{R}}$ denotes the summation for all the constituents of the reactants denoted by i , \bar{u}_i is the tabulated value of the internal energy for the constituent at the required temperature T_0 or T_1 , and n_i the amount of substance of the constituent.

Alternatively if a mass base is used for the tabulated values or calculation

$$U_{R_0} - U_{R_1} = \sum_{\mathbf{R}} m_i (u_{i_0} - u_{i_1}) \quad (4.14)$$

where u_i is the internal energy per unit mass.

In terms of the specific heats which are average values for the required temperature range

$$U_{R_0} - U_{R_1} = \sum_{\mathbf{R}} m_i c_{v_i} (T_0 - T_1) = (T_0 - T_1) \sum_{\mathbf{R}} m_i c_{v_i} \quad (4.15)$$

and similar expressions for the products are

$$U_{P_2} - U_{P_1} = \sum_{\mathbf{P}} n_i (\bar{u}_{i_2} - \bar{u}_{i_1}) \quad (4.16)$$

$$U_{P_2} - U_{P_1} = \sum_{\mathbf{P}} m_i (u_{i_2} - u_{i_1}) \quad (4.17)$$

$$U_{P_2} - U_{P_1} = \sum_{\mathbf{P}} m_i c_{v_i} (T_2 - T_1) = (T_2 - T_1) \sum_{\mathbf{P}} m_i c_{v_i} \quad (4.18)$$

Note that $n_i \bar{c}_{v_i} = m_i c_{v_i}$.

The process has been analysed on the basis of a non-flow process which involves combustion at constant volume. A similar analysis can be made for a steady-flow or constant pressure combustion process in which the changes in enthalpy are important

$$H_{P_2} - H_{R_1} = \underbrace{(H_{P_2} - H_{P_0})}_{\text{Products}} + \Delta H_0 + \underbrace{(H_{R_0} - H_{R_1})}_{\text{Reactants}} \quad (4.19)$$

where $\Delta H_0 = \text{enthalpy of reaction at } T_0$ and

$$\Delta H_0 = H_{P_0} - H_{R_0} \text{ and is always negative} \quad (4.20)$$

The molar enthalpy of reaction is defined as $\Delta \tilde{h}^\circ = \Delta H_0/n$ at 1 bar where n is the amount of substance of the fuel.

The expressions for the change in enthalpy of reactants and products are

$$H_{R_0} - H_{R_1} = \sum_{\mathbf{R}} n_i (\tilde{h}_{i_0} - \tilde{h}_{i_1}) \quad (4.21)$$

$$H_{R_0} - H_{R_1} = \sum_{\mathbf{R}} m_i (h_{i_0} - h_{i_1}) \quad (4.22)$$

and if mean specific heats are used

$$H_{R_0} - H_{R_1} = \sum_{\mathbf{R}} m_i c_{p_i} (T_0 - T_1) = (T_0 - T_1) \sum_{\mathbf{R}} m_i c_{p_i} \quad (4.23)$$

$$H_{P_2} - H_{P_0} = \sum_{\mathbf{P}} n_i (\tilde{h}_{i_2} - \tilde{h}_{i_0}) \quad (4.24)$$

$$H_{P_2} - H_{P_0} = \sum_{\mathbf{P}} m_i (h_{i_2} - h_{i_0}) \quad (4.25)$$

and if mean specific heats are used

$$H_{P_2} - H_{P_0} = \sum_{\mathbf{P}} m_i c_{p_i} (T_2 - T_0) = (T_2 - T_0) \sum_{\mathbf{P}} m_i c_{p_i} \quad (4.26)$$

Note that $n_i \tilde{c}_{p_i} = m_i c_{p_i}$.

In the equations for the change in internal energy and enthalpy for reactants and products, and for ΔU_0 and ΔH_0 , if a change in state takes place (e.g. from liquid fuel to vapour), a term describing this process must be included.

Nothing has been said of the air–fuel ratio for combustion during the determination of ΔU_0 or ΔH_0 . Consideration will show that this does not matter provided there is sufficient air to ensure complete combustion. Excess oxygen, like the nitrogen present, starts and finishes at the reference temperature T_0 and so suffers no change in internal energy or enthalpy, thus not affecting ΔU_0 or ΔH_0 .

From the definition of the enthalpy of a perfect gas

$$H = U + pV = U + n\tilde{R}T$$

So if we are concerned only with gaseous mixtures in the reaction then for products and reactants

$$H_{P_0} = U_{P_0} + n_P \tilde{R}_0 T_0 \quad \text{and} \quad H_{R_0} = U_{R_0} + n_R \tilde{R}_0 T_0$$

where n_P and n_R are the amounts of substance of products and reactants respectively, and the temperature is the reference temperature T_0 .

Then, using equations (7.15) and (7.24), we have

$$\Delta H_0 = \Delta U_0 + (n_P - n_R) \tilde{R} T_0 \quad (4.27)$$

If there is no change in the amount of substance during the reaction, or if the reference temperature is absolute zero, then ΔH_0 and ΔU_0 will be equal.

Example 1: Calculate the theoretical air/ fuel ratio ($A/F_{\text{Stoichiometric}}$) for completely burned hexane fuel (C_6H_{14}). Then calculate the actual air/ fuel ratio (A/F_{Actual}) and wet volumetric analysis of the combustion products in both cases :

- Excess air 20%.
- 80% from the theoretical air.

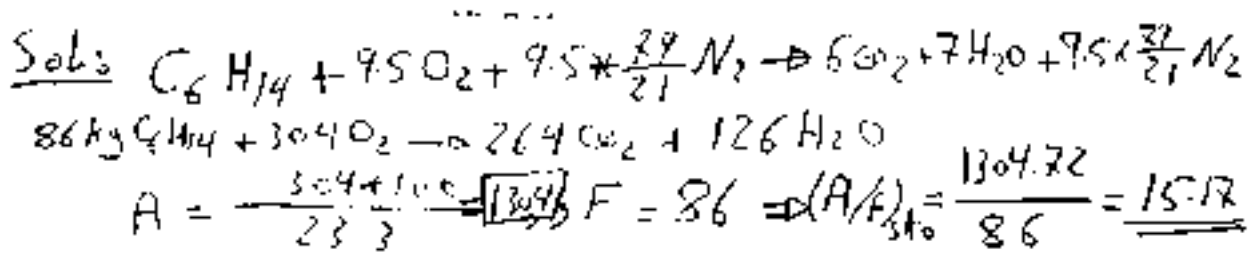

a) Excess air 20%

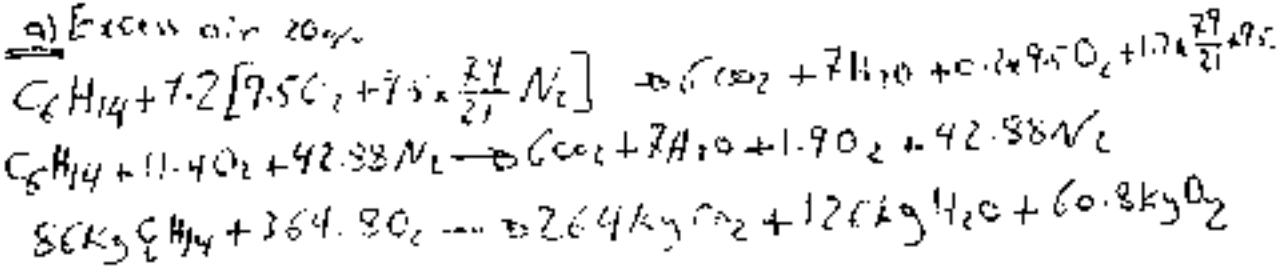

$A/F_{\text{Actual}} = \frac{364.8 + 100}{23.3 \times 86} = \underline{\underline{1.8205}}$
 - Volumetric analysis (wet)

Total Mole of Products = $6 + 7 + 1.9 + 42.98 = 57.79$

$CO_2 = \frac{6}{57.79} \times 100 = 10.38\%$ $H_2O = 12.11\%$

$N_2 = \frac{42.98}{57.79} \times 100 = 74.32\%$

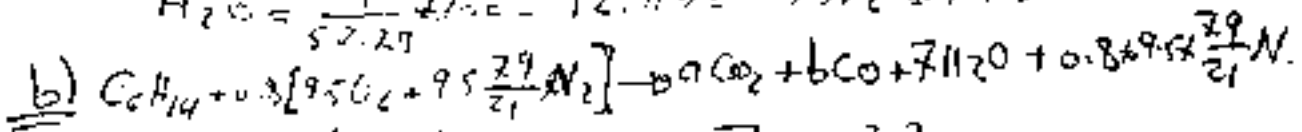

$C: 6 = a + b \dots (1)$

$O_2: 0.8 \times 9.5 = a + \frac{b}{2} + \frac{7}{2} \dots (2)$ $a = 2.2$
 $b = 3.8$

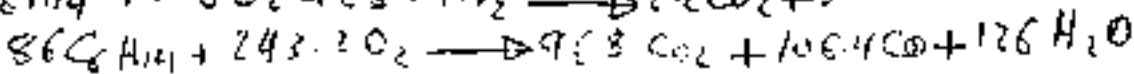
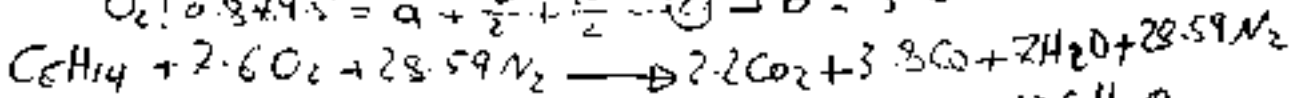

$A/F_{\text{Actual}} = \frac{243.2 + 100}{23.3 \times 86} = \underline{\underline{12.13}}$

- Wet Volumetric analysis: Total mole of Products = $2.2 + 3.8 + 7 + 28.59 = 41.59$

$CO_2 = 5.24\%$ $N_2 = 68.74\%$ $H_2O = 16.83\%$

$CO = 9.19\%$

Example 7.1

A sample of dry anthracite has the following composition by mass.

C 90%; H 3%; O 2.5%; N 1%; S 0.5%; ash 3%

Calculate:

- (i) the stoichiometric A/F ratio;
 (ii) the A/F ratio and the dry and wet analysis of the products of combustion by mass and by volume, when 20% excess air is supplied.

Solution :-

Element	Mass Per Kg Coal	Combustion Equation	Oxygen required for kg of Coal	Products per kg of Coal
C	0.9	$C + O_2 \rightarrow CO_2$ $12 + 32\text{kg} \rightarrow 44\text{kg}$	$0.9 \times \frac{32}{12} = 2.4$	$0.9 \times \frac{44}{12}$ $= 3.3\text{kg } CO_2$
H	0.03	$2H_2 + O_2 \rightarrow 2H_2O$ $1\text{kg} + 8\text{kg} \rightarrow 9\text{kg}$	$0.03 \times \frac{8}{1}$ $= 0.24$	0.03×9 $= 0.27\text{kg } H_2O$
O	0.025	—	$= 0.025\text{kg}$	—
N	0.01	—	—	$0.01\text{kg } N_2$
S	0.005	$S + O_2 \rightarrow SO_2$ $32\text{kg} + 32\text{kg} \rightarrow 64\text{kg}$	$0.005 \times \frac{32}{32}$ $= 0.005\text{kg}$	$0.005 \times \frac{64}{32}$ $= 0.01\text{kg } SO_2$
ash	0.03	—	—	—

Total = 2.62 kg

∴ from table O_2 required per kg of Coal = 2.62 kg∴ air required per kg of Coal = $\frac{2.62}{0.233} = 11.25\text{kg}$ ∴ The Stoichiometric A/F ratio = $\frac{11.25}{1}$ Ans (i)

$$(ii) \text{ Excess Air \%} = \frac{A/F_{\text{actual}} - A/F_{\text{stoi}}}{A/F_{\text{stoi}}}$$

$$0.2 = \frac{A/F_{\text{act}} - 11.25}{11.25} \Rightarrow A/F_{\text{actual}} = \frac{13.5}{1}$$

From $A/F_{\text{actual}} = 13.5/1$

$$\circ N_2 \text{ Supplied} = 0.767 \times 13.5 = 10.36 \text{ kg } N_2$$

$$O_2 \text{ Supplied} = 0.233 \times 13.5 = 3.144 \text{ kg } O_2$$

In products then, we have

$$N_2 = 10.36 + 0.01 = 10.37 \text{ kg } N_2$$

$$\text{Excess } O_2 = 3.144 - 2.62 = \underline{\underline{0.524 \text{ kg}}}$$

Products	Mass/kg Coal	% by Mass Wet/dry	kg/kmole	kmole/kg Coal	% by Vol. Wet	% by Vol. dry
CO ₂	3.3	22.8	44	0.075	15.77	16.3
H ₂ O	0.27	1.87	18	0.015	3.16	—
SO ₂	0.01	0.07	64	0.0002	0.03	0.03
O ₂	0.52	3.6	32	0.0162	3.4	3.51
N ₂	10.37	71.65	28	0.37	77.8	80.3
Sum. wet	14.47 kg			Sum. wet 0.4764		
Sum dry	14.2 kg			Sum dry 0.4614		

Example3: The analysis of the dry exhaust gas from an internal combustion engine gave 12% CO₂, 2% CO, 4% CH₄, 1% H₂, 4.5% O₂, 76.5% N₂. Calculate the proportions by mass of carbon to hydrogen in the fuel, assuming it to be a pure hydrocarbon, and the A/F ratio used.

Solution Let the unknown mass fraction of carbon in the fuel be x kg per kilogram of fuel. Then we can write the combustion equation as follows:

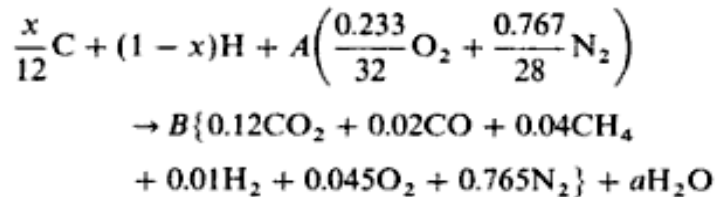

As in Example 7.8 there are four unknowns and four possible equations.

$$\text{Carbon balance: } x/12 = B(0.12 + 0.02 + 0.04) \\ x = 2.16B \quad [1]$$

$$\text{Hydrogen balance: } (1 - x) = (4 \times 0.04)B + (2 \times 0.01)B + 2a \\ a = 0.5 - 0.5x - 0.09B \quad [2]$$

$$\text{Oxygen balance: } \frac{0.233A}{32} = B\left(0.12 + \frac{0.02}{2} + 0.045\right) + \frac{a}{2} \\ a = 0.01456A - 0.35B \quad [3]$$

$$\text{Nitrogen balance: } 0.767A/28 = 0.765B \\ A = 27.927B \quad [4]$$

Equating [2] and [3] we have

$$0.5 - 0.5x - 0.09B = 0.01456A - 0.35B \\ A = 34.341 - 34.341x + 17.857B$$

Then using equation [4]

$$34.341 - 34.341x + 17.857B = 27.927B \\ B = 3.41 - 3.41x$$

Substituting in [1]

$$x = 7.366 - 7.366x$$

$$\text{i.e. } x = 0.8805$$

The composition of the fuel is therefore 88.05% C, 11.95% H.

$$\text{Also, } B = 3.41 \times 0.1195 = 0.4075$$

Then in equation [4],

$$A = 27.927 \times 0.4075 = 11.38$$

$$\text{i.e. } A/F \text{ ratio} = 11.38$$

Example 4:

For benzene vapour (C_6H_6) at $25^\circ C$ $\Delta\tilde{h}_0$ is $-3\,301\,397$ kJ/kmol with the H_2O in the liquid phase. Calculate $\Delta\tilde{h}_0$ for the H_2O in the vapour phase.

If the H_2O remains as a vapour the heat transferred to the surroundings will be less than that when the vapour condenses, by the amount due to the change in enthalpy of the vapour during condensation at the reference temperature.

$$\Delta\tilde{h}_0(\text{vap}) = \Delta\tilde{h}_0(\text{liq}) + m_s h_{fg_0}$$

where m_s is the mass of H_2O formed for 1 kmol of fuel; h_{fg_0} is the change in enthalpy of steam between saturated liquid and saturated vapour at the reference temperature T_0 and is 2441.8 kJ/kg at $25^\circ C$.

For the reaction

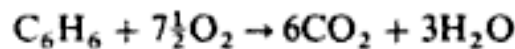

Therefore 3 kmol of H_2O are formed on combustion of 1 kmol of C_6H_6 ; 3 kmol of $H_2O = 3 \times 18 = 54$ kg H_2O .

$$\begin{aligned}\Delta\tilde{h}_0(\text{vap}) &= -3\,301\,397 + (54 \times 2441.8) \\ &= -3\,169\,540 \text{ kJ/kmol}\end{aligned}$$

Example 5:

Calculate the specific internal energy of reaction for the combustion of benzene (C_6H_6) vapour at $25^\circ C$ given that $\Delta\tilde{h}_0 = -3\,169\,540$ kJ/kmol and the H_2O is in the vapour phase.

Solution The combustion equation is

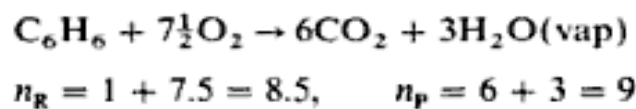

From equation (7.31)

$$\begin{aligned}\Delta U_0 &= \Delta H_0 - (n_P - n_R)\tilde{R}T_0 \\ &= -(3\,169\,540 \times 1) - \left\{ (9 - 8.5) \times 8.3145 \times 298 \right\}\end{aligned}$$

where $T_0 = 273 + 25 = 298$ K

$$\text{i.e. } \Delta U_0 = -3\,169\,540 - 1239 = -3\,170\,779 \text{ kJ}$$

(note that ΔU_0 is negligibly different from ΔH_0)

$$1 \text{ kmol of } C_6H_6 = (6 \times 12) + (6 \times 1) = 78 \text{ kg}$$

therefore

$$\Delta u_0 = -\frac{3\,170\,779}{78} = -40\,651 \text{ kJ/kg}$$

Example 6: The combustion enthalpy of liquid heptane (C_7H_{16}) fuel is equal to (-44560 kJ/kg) at (25 °C) when the water is in steam products. We burn this fuel with constant pressure, regular generation, and true stoichiometric percent. If the temperature of fuel and air is at (15°C) at beginning and the temperature of products is (2050 °C). Calculate the heat transferred from burning the heptane fuel. Take the specific heat of liquid heptane (2.3 kJ/kg.K).

للمنفاعات ($O_2= 0.917$; $N_2= 1.04$; $H_2O(vap.)= 1.862$ kJ/kg.K)

للتواتج ($CO_2= 1.336$; $N_2= 1.252$; $H_2O(vap.)= 2.651$ kJ/kg.K)

Solution: -

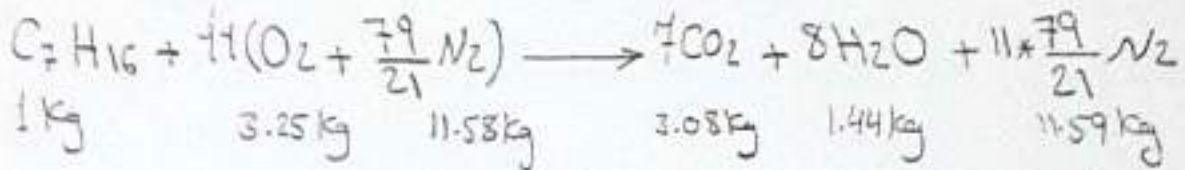

ملاحظة / المعادلة المتوازنة لدرجات (1 kg) من الهبتان .
 بسبب الجريان المنتظم للهواء \Leftarrow

$$Q - W = \Delta H$$

$$Q = H_{P_{2050}} - H_{R_{25}} = (H_{P_{2050}} - H_{P_{25}}) + \Delta H_{25} + (H_{R_{25}} - H_{R_{15}})$$

$$\therefore H_{R_{25}} - H_{R_{15}} = \sum_R m_i C_{p_i} (25 - 15)$$

$$= [(1 \times 2.3) + (3.25 \times 0.917) + (11.58 \times 1.04)] (25 - 15) = 175.8 \text{ kJ/kg}$$

$$H_{P_{2050}} - H_{P_{25}} = \sum_P m_i C_{p_i} (2050 - 25)$$

$$= [(3.08 \times 1.336) + (1.44 \times 2.651) + (11.59 \times 1.252)] (2050 - 25)$$

$$= 45447 \text{ kJ/kg of fuel}$$

$$\therefore Q = 45447 - 44560 + 175.8 = 1062.8 \text{ kJ/kg of fuel.}$$

Example 7: A cylinder contains a mixture of gasoline and air and the ratio of air to fuel is (A/F= 15/1) at 300 ° C. The internal energy of gasoline is equal ($\Delta U_o = -406100$ kJ/mole) at (25 ° C). when the full combustion is at constant pressure and the temperature of the products is (3250 ° C). Calculate the heat transferred from the combustion.

($O_2 = 22.3$; $N_2 = 21.2$; $C_6H_6 = 21.5$ kJ/mole.K) للمفاعلات

($CO_2 = 46.5$; $N_2 = 24.2$; $H_2O(vap.) = 27.3$; $O_2 = 25.5$ kJ/kg.K) للنواتج

Solution:-

$$Q = (H_{P3250} - H_{R300}) = (H_{P3250} - H_{P25}) + \Delta H_o + (H_{R25} - H_{R300})$$

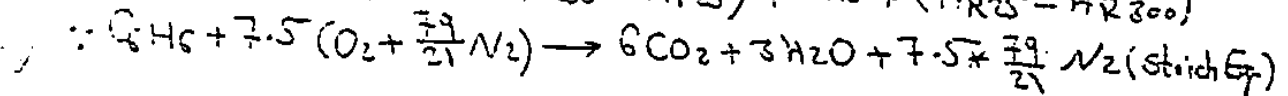

$$\therefore \frac{A}{F} = \frac{m_{air}}{m_{fuel}} \Rightarrow 0.233 = \frac{O_2}{air} \Rightarrow air = \frac{11 \times 2 \times 7.5}{0.233} = 1030 \text{ kg}$$

$$\frac{A}{F} \text{ stoich} = \frac{1030}{78} = 13.2 \Rightarrow \text{the products contain } (O_2 \text{ excess})$$

where $A/F \text{ stoich} < A/F \text{ act}$.

$$\frac{A}{F} \text{ act} = 15 = \frac{m_{air}}{m_{fuel}} \Rightarrow m_{air} = 78 \times 15 = 1170 \Rightarrow O_2 = 272.6 \text{ kg}$$

$$\therefore O_2 = 8.5 \text{ Mole.}$$

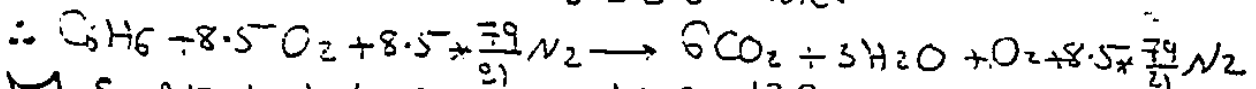

$$M.S = A/F \text{ stoich} / A/F \text{ act} \Rightarrow M.S = \frac{13.2}{15} = 0.88$$

$$\therefore A/F \text{ act} = 1.136 A/F \text{ stoich} \leftarrow \text{from Stoich. Eq} \Rightarrow n_p - n_r = 0.5$$

$$\Delta H_o = -406100 + 0.5 \times 8.314 \times 298 = -404861 \text{ kJ/mole.}$$

$$\text{but, we have excess air } (0.136) \Rightarrow \Delta H_o = 1.136 \times -404861$$

$$= -459922 \text{ kJ/mole.}$$

$$(H_{P3250} - H_{P25}) = \sum_{P_i} n_i C_{p_i} (3250 - 25)$$

$$= [5 \times 46.5 + 3 \times 27.3 + 1 \times 25.5 + 32 \times 24.2] (3250 - 25) = 3743580 \text{ kJ/mole.}$$

$$(H_{R25} - H_{R300}) = \sum_{R_i} n_i C_{p_i} (25 - 300)$$

$$= [1 \times 21.5 + 8.5 \times 22.3 + 32 \times 24.2] (25 - 300) = -270999 \text{ kJ/mole.}$$

$$Q = 3743580 - 459922 - 270999 = 3012659 \text{ kJ/mole.}$$